



QUALITY
WITHOUT
COMPROMISE

PRICE LIST

INDUSTRIAL

2022



WHAT WE DO



Manually laminated hand lay-up polyester resin fiberglass to controlled thickness.



The strength of steel
The chemical corrosion resistance of polyester.

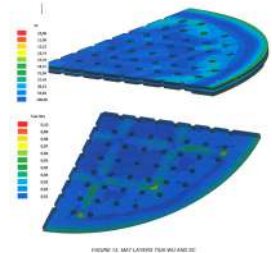

Engineering soul.



Expected lifespan: more than 30 years.

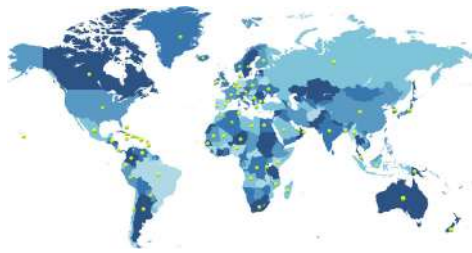

Sold worldwide with complete reliability since 1970.



Armoured nozzle plate.



Optimized distribution systems for flow distribution and each application

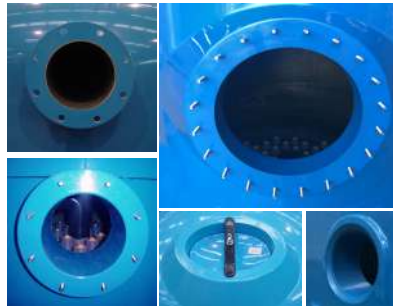

Complete safety:
Connections are part of the structure.



100% full vision inside:
Methacrylate sightglasses



Each and every filter is tested.



Closed legs are part of the filter structure.



On site assembling



Special colors on demand



UV resistant external gel coat.



Wind & Seismic Calculation



Replace/Upgrade your filter
PLUG & PLAY



CALPLAS PRESSURE VESSELS

Calplas vessels have been used in industrial projects worldwide since 1970 and it is one

WHY CALPLAS?

The first question is which is the best material for a vessel?

Steel tanks :

PROS: Very reliable and strong vessels.

CONS: These suffer from corrosion and require continuous maintenance to replace the different linings used (epoxy painting, rubber coatings...).

Fiber Glass vessels:

PROS: No corrosion.

CONS: Most polyester vessels are built for the swimming pool industry, where both pressure requirements and reliability fall far short of what is required in any industrial project.

Why choose between one or the other?

Calplas uses only the most reliable GRP Polyester technology in its manufacturing process. MANUALLY LAMINATED HAND LAY UP. This means that the fibers are oriented in the directions of the maximum tensions of the filter, strictly calculated. On top, this is combined with **encapsulated internal steel reinforcement** used at all points where the filter is under additional stress. This makes our filters the most reliable on the market.

Calplas filters are as strong as steel with the corrosion resistance of the polyester reinforced with fiberglass



OUR EXPERIENCE

No other manufacturer has more than 50 years experience in :

- Filtration systems
- Ion exchanger vessels
- Adequate internal lining adaptation

After 50 years of manufacturing in direct collaboration with water treatment companies and pool distributors, **Calplas is proud to manufacture the best filters in the world**, with an outstanding reliability, durability and performance.



INDEX

| | |
|--|-------|
| FA SERIES Ø 415-960 | 5 |
| HFS/HFX SERIES Ø 415-960 | 6 |
| AFM SERIES Ø 520-960 | 7 |
| D SERIES Ø 415-960..... | 8 |
| DC SERIES Ø 415-960..... | 9 |
| DCP SERIES Ø 415-960..... | 10 |
| DPP SERIES Ø 415-960..... | 11 |
| FB SERIES Ø 1010-3000..... | 12 |
| D SERIES Ø 1010-3000..... | 13 |
| DC SERIES Ø 1010-3000..... | 14 |
| DP SERIES Ø 1010-3000..... | 15 |
| HORIZONTAL FILTERS..... | 16 |
| CARTRIDGE FILTERS..... | 17 |
| KP SERIES Ø 1010-1840..... | 18 |
| KPP SERIES Ø 1010-1840..... | 19 |
| DPC SERIES Ø 2040-3000..... | 20 |
| DPPC SERIES Ø 2040-3000..... | 21 |
| DPPP & KPPP SERIES Ø415-3000 | 22 |
| MIXED BEDS..... | 23 |
| STANDARD PUMP STRAINERS & COLLECTORS | 24 |
| CUSTOMIZED PUMP STRAINERS..... | 25 |
| DEGASSIFIERS | 26 |
| DECANTERS | 27 |
| TANKS & MIXING TANKS | 28 |
| MEDIATRAPS | 29 |
| AFM FILTER & PILOT PLANT SKID..... | 30 |
| ADDITIONAL ELEMENTS | 31 |
| AFM MEDIA | 32-33 |
| BESGO VALVES & ACCESORIES | 34 |
| FLOW METER & AIR DIFFUSERS..... | 35 |
| USEFUL INFORMATION..... | 36-37 |
| PACKAGING | 38 |
| NOTES..... | 39 |

FA SERIES Ø 415-960

FA SERIES

Manufactured and calculated according to EN 13121-3.
 Material: Hand lay-up polyester with fiberglass (max quality polyester tech).
 Steel reinforced GRP vessel.
 All threaded connections are part of the structure of the filter in GRP.
 Closed legs & part of the filter structure.
 Top access.
 Design temperature 40°C.
 Laterals distribution.
 Top distributor according to the media/application.
 Tested 1.5 times design pressure

ADDITIONAL OPTIONS

Higher temperatures. (Ask us)
 High-chemical resistance. (Ask us) [See page 31](#)
 Anchorage system to ground. [See page 31](#)
 Seismic calculations. (Ask us)
 Drinking water / Food contact. (Ask us)
 BESGO READY FILTERS [See page 34](#)

FA SERIES BED HEIGHT 350-450

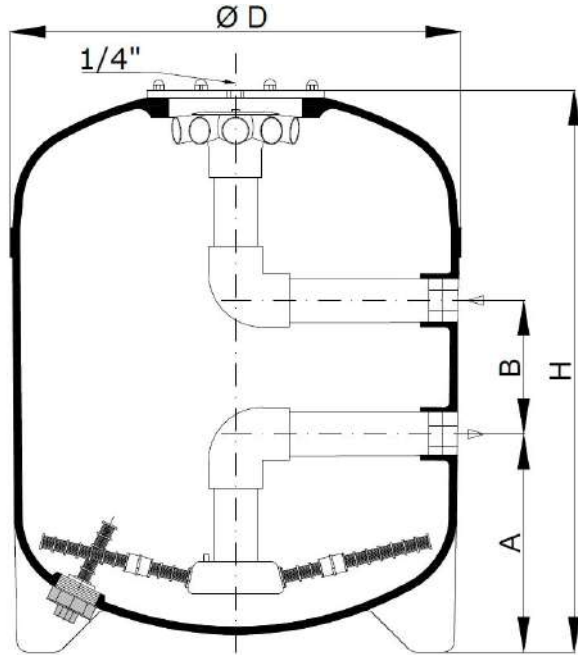

| Design Pressure | | FA-6 Ø415 H=730 | FA-8 Ø460 H=740 | FA-10 Ø520 H=800 | FA-15 Ø640 H=830 | FA-20 Ø720 H=930 | FA-30 Ø840 H=950 | FA-35 Ø960 H=1050 |
|-------------------------|-------|-----------------------|-----------------------|------------------------|------------------------|------------------------|------------------------|-------------------------|
| 2.5 Kg /cm ² | Ref. | 102041 | 102046 | 102052 | 102064 | 102072 | 102084 | 102096 |
| | Price | 790 € | 860 € | 1 030 € | 1 195 € | 1 405 € | 1 670 € | 2 370 € |
| 5 Kg /cm ² | Ref. | 315041 | 315046 | 315052 | 315064 | 315072 | 315084 | 315096 |
| | Price | 890 € | 948 € | 1 154 € | 1 452 € | 1 810 € | 2 146 € | 3 063 € |
| 7 Kg /cm ² | Ref. | 317041 | 317046 | 317052 | 317064 | 317072 | 317084 | 317096 |
| | Price | 1 148 € | 1 263 € | 1 466 € | 1 868 € | 2 379 € | 2 894 € | 3 852 € |



Integrated GRP threads



Transparent top lid



Steel Top lid
5 / 7 kg/cm²



Arms collector



Arms
0.3 mm



Diffuser for Sand / AFM



Emptying plug



HFS/HFX SERIES Ø 415-960

HFX SERIES

Manufactured and calculated according to EN 13121-3.
 Material: Hand lay-up polyester with fiberglass (max quality polyester tech).
 Steel reinforced GRP vessel.
 All threaded connections are part of the structure of the filter in GRP.
 Closed legs & part of the filter structure.
 Top access.
 Design temperature 40°C.
 Laterals distribution.
 Top distributor according to the media/application.
 Tested 1.5 times design pressure
 Methacrylate sightglass or methacrylate top lid (2.5kg/cm²)

ADDITIONAL OPTIONS

Higher temperatures. (Ask us)
 High-chemical resistance. (Ask us) [See page 31](#)
 Flange connections available [See page 31](#)
 Anchorage system to ground. [See page 31](#)
 Seismic calculations. (Ask us)
 Drinking water / Food contact. (Ask us)
 BESGO READY FILTERS [See page 34](#)

HFS SERIES P=2.5 Kg/cm²

HFX SERIES P=5/7 Kg/cm²

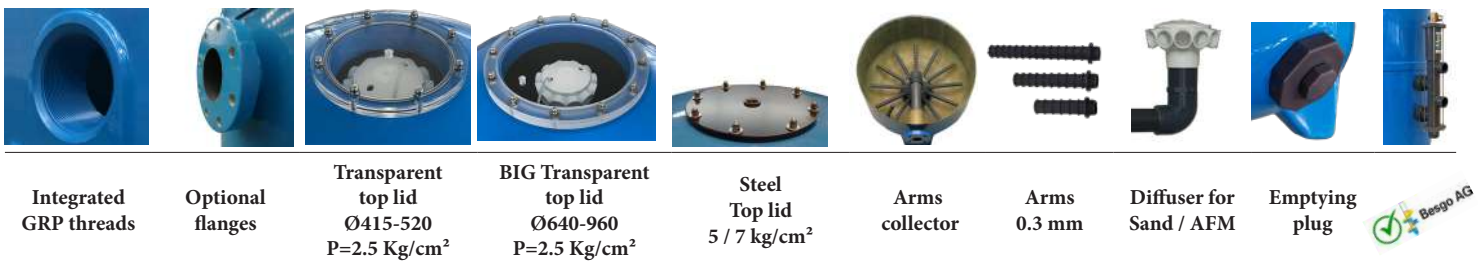
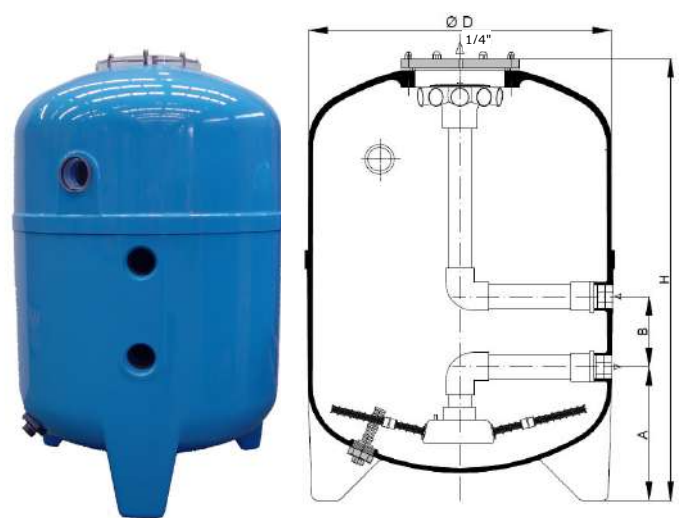
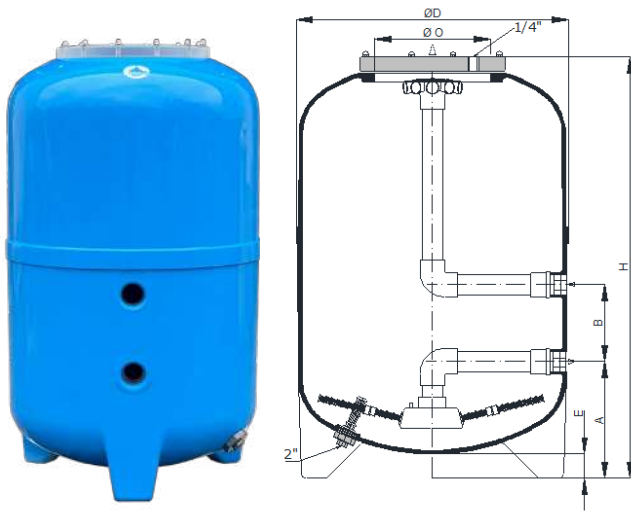

| Design Pressure | | HFS-6 Ø415 H=861 | HFS-8 Ø460 H=861 | HFS-10 Ø520 H=931 | HFS-15 Ø640 H=1090 | HFS-20 Ø720 H=1140 | HFS-30 Ø840 H=1190 | HFS-35 Ø960 H=1240 |
|-------------------------|-------|------------------------|------------------------|-------------------------|--------------------------|--------------------------|--------------------------|--------------------------|
| 2.5 Kg /cm ² | Ref. | 112041 | 112046 | 112052 | 112064 | 112072 | 112084 | 112096 |
| | Price | 880 € | 965 € | 1 170 € | 1 625 € | 1 870 € | 2 160 € | 2 815 € |
| Design Pressure | | HFX-6 Ø415 H=861 | HFX-8 Ø460 H=861 | HFX-10 Ø520 H=931 | HFX-15 Ø640 H=986 | HFX-20 Ø720 H=1105 | HFX-30 Ø840 H=1165 | HFX-35 Ø960 H=1175 |
| 5 Kg /cm ² | Ref. | 315141 | 315146 | 315152 | 315164 | 315172 | 315184 | 315196 |
| | Price | 1 234 € | 1 291 € | 1 435 € | 1 957 € | 2 262 € | 2 742 € | 3 356 € |
| 7 Kg /cm ² | Ref. | 317141 | 317146 | 317152 | 317164 | 317172 | 317184 | 317196 |
| | Price | 1 515 € | 1 670 € | 1 878 € | 2 527 € | 2 893 € | 3 175 € | 4 235 € |

AFM SERIES Ø 520-960

AFM SERIES

Manufactured and calculated according to EN 13121-3.
 Material: Hand lay-up polyester with fiberglass (max quality polyester tech).
 Steel reinforced GRP vessel.
 All threaded connections are part of the structure of the filter in GRP.
 Closed legs & part of the filter structure.
 Top access.
 Design temperature 40°C.
 Laterals distribution.
 Top distributor according to the media/application.
 Tested 1.5 times design pressure

ADDITIONAL OPTIONS

Higher temperatures. (Ask us)
 High-chemical resistance. (Ask us) [See page 31](#)
 Flange connections available [See page 31](#)
 Anchorage system to ground. [See page 31](#)
 Seismic calculations. (Ask us)
 Drinking water / Food contact. (Ask us)
 BEGO READY FILTERS [See page 34](#)

2 Orientation available: Pos 6 X=6 (Standard) / Pos 2 X=2

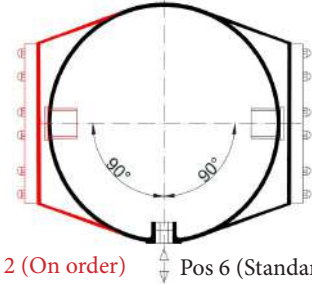

Pos 2 (On order) Pos 6 (Standard)

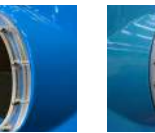
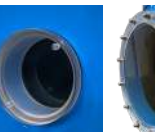
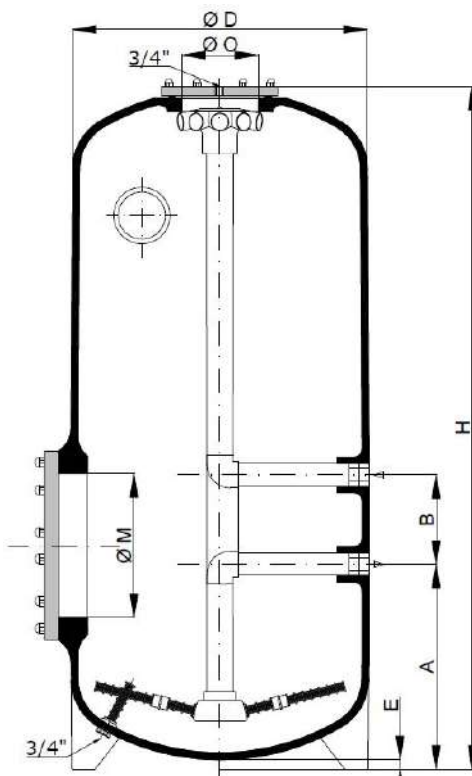

Integrated GRP threads

Transparent top lid
2.5 Kg/cm²

Steel Top lid
5 / 7 kg/cm²

Arms collector

Arms
0.3 mm

Diffuser for Sand / AFM

Sightglass

Transparent side hatch
2.5 Kg/cm²

Manhole lid
P=5/7 Kg/ cm²

Emptying plug



| Design Pressure | | AFM 520 H=1400 | AFM 640 H=1440 | AFM 720 H=1440 | AFM 840 H=1460 | AFM 960 H=1520 |
|------------------------|-------|-------------------|-------------------|-------------------|-------------------|-------------------|
| 2.5 Kg/cm ² | Ref. | 112152.X | 112164.X | 112172.X | 112184.X | 112196.X |
| | Price | 1 965 € | 2 310 € | 2 650 € | 2 945 € | 3 770 € |
| 5 Kg/cm ² | Ref. | 315252.X | 315264.X | 315272.X | 315284.X | 315296.X |
| | Price | 2 782 € | 3 291 € | 3 606 € | 4 176 € | 4 982 € |
| 7 Kg/cm ² | Ref. | 317252.X | 317264.X | 317272.X | 317284.X | 317296.X |
| | Price | Check | Check | Check | Check | Check |

D SERIES Ø 415-960

D SERIES

Manufactured and calculated according to EN 13121-3.
 Material: Hand lay-up polyester with fiberglass (max quality polyester tech).
 Steel reinforced GRP vessel.
 All threaded connections are part of the structure of the filter in GRP.
 Closed legs & part of the filter structure.
 Top & bottom access.
 Design temperature 40°C.
 Laterals distribution.
 Top distributor according to the media/application.
 Tested 1.5 times design pressure

ADDITIONAL OPTIONS

Higher temperatures. (Ask us)
 High-chemical resistance. (Ask us) [See page 31](#)
 Cylindrical height ad-hoc. ([Check below](#))
 Flange connections available. [See page 31](#)
 Additional sight glass. [See page 31](#)
 Anchorage system to ground. [See page 31](#)
 Seismic calculations. (Ask us)
 Drinking water / Food contact. (Ask us)

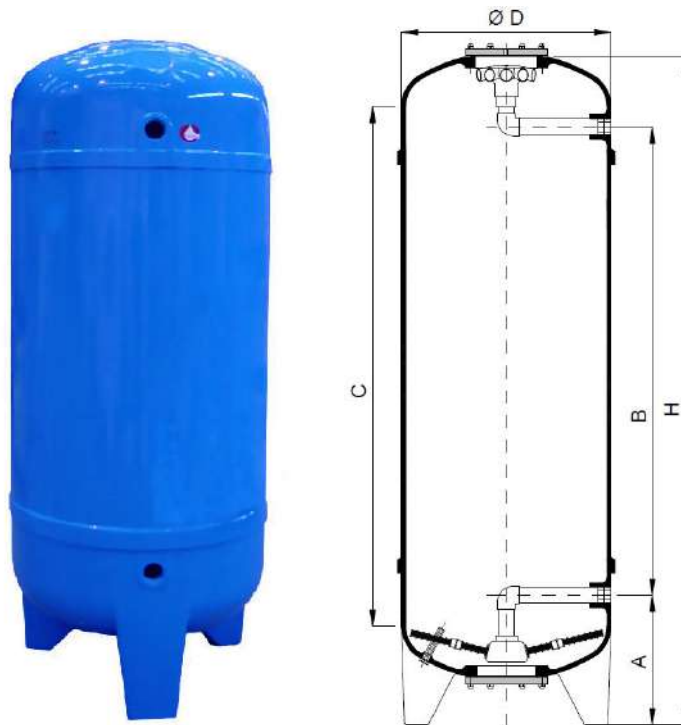

Threaded connections Arms collector 0.3 mm Optional Arms collector 0.2/0.5 mm Diffuser according to application Optional Sightglass Standard Top lid Optional flanges Customizable height

| Design Pressure | | D-415 C=1500 H=1856 | D-460 C=1500 H=1867 | D-520 C=1500 H=1887 | D-640 C=1500 H=1941 | D-720 C=1500 H=2010 | D-840 C=1500 H=2090 | D-960 C=1500 H=2168 |
|-------------------------|----------|---------------------------|---------------------------|---------------------------|---------------------------|---------------------------|---------------------------|---------------------------|
| 2.5 Kg /cm ² | Ref. | 332141 | 332146 | 332152 | 332164 | 332172 | 332184 | 332196 |
| | Price | 2 070 € | 2 460 € | 2 919 € | 3 244 € | 3 649 € | 4 345 € | 5 316 € |
| | Δ 100 mm | 26 € | 33 € | 44 € | 57 € | 68 € | 90 € | 95 € |
| 5 Kg /cm ² | Ref. | 335141 | 335146 | 335152 | 335164 | 335172 | 335184 | 335196 |
| | Price | 2 553 € | 3 024 € | 3 587 € | 3 979 € | 4 503 € | 5 346 € | 6 525 € |
| | Δ 100 mm | 40 € | 54 € | 63 € | 78 € | 95 € | 128 € | 141 € |
| 7 Kg /cm ² | Ref. | 337141 | 337146 | 337152 | 337164 | 337172 | 337184 | 337196 |
| | Price | 3 179 € | 3 773 € | 4 543 € | 4 962 € | 5 585 € | 6 673 € | 8 069 € |
| | Δ 100 mm | 51 € | 67 € | 70 € | 101 € | 129 € | 164 € | 200 € |

Recomended! Sightglass +255 € +255 € +255 € +320 € +320 € +320 € +375 €

Minimum C Check out FA & HFX models (Page 6)

Maximum C for 1 cylinder Table valid for calculation up to 2500 mm

We can manufacture filters for higher cylindrical height (please check with us)

DC SERIES Ø 415-960

DC SERIES

Manufactured and calculated according to EN 13121-3.
 Material: Hand lay-up polyester with fiberglass (max quality polyester tech).
 Steel reinforced GRP vessel.
 All threaded connections are part of the structure of the filter in GRP.
 Closed legs & part of the filter structure.
 Manhole access.
 Top & bottom access.
 Design temperature 40°C.
 Laterals distribution.
 Top distributor according to the media/application.
 Tested 1.5 times design pressure

ADDITIONAL OPTIONS

Higher temperatures. (Ask us)
 High-chemical resistance. (Ask us) [See page 31](#)
 Cylindrical height ad-hoc. ([Check below](#))
 Flange connections available. [See page 31](#)
 Sight glass. [See page 31](#)
 Anchorage system to ground. [See page 31](#)
 Seismic calculations. (Ask us)
 Drinking water / Food contact. (Ask us)

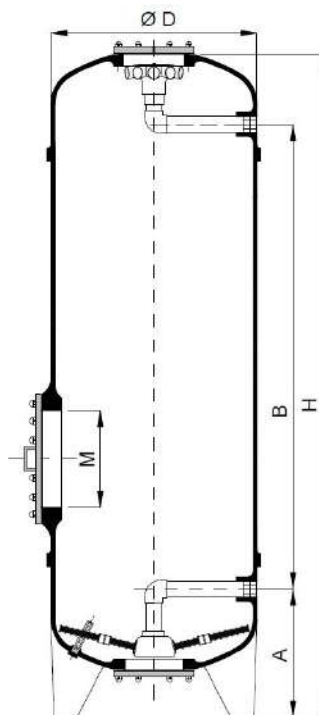

Threaded connections

Plastized Manhole lid

Arms collector 0.3 mm

Optional Arms collector 0.2/0.5 mm

Diffuser according to application

Optional sightglass

Standard Top lid

Optional flanges

Customizable height

| Design Pressure | | DC-415 C=1500 H=1856 | DC-460 C=1500 H=1867 | DC-520 C=1500 H=1887 | DC-640 C=1500 H=1941 | DC-720 C=1500 H=2010 | DC-840 C=1500 H=2090 | DC-960 C=1500 H=2168 |
|--------------------------|------------|---|----------------------------|----------------------------|----------------------------|----------------------------|----------------------------|----------------------------|
| 2.5 Kg/cm ² | Ref. | 332241 | 332246 | 332252 | 332264 | 332272 | 332284 | 332296 |
| | Price | 2 861 € | 3 251 € | 3 710 € | 4 203 € | 4 608 € | 5 305 € | 6 483 € |
| | Δ 100 mm | 26 € | 33 € | 44 € | 57 € | 68 € | 90 € | 95 € |
| 5 Kg/cm ² | Ref. | 335241 | 335246 | 335252 | 335264 | 335272 | 335284 | 335296 |
| | Price | 3 344 € | 3 816 € | 4 378 € | 4 939 € | 5 461 € | 6 306 € | 7 693 € |
| | Δ 100 mm | 37 € | 50 € | 59 € | 73 € | 89 € | 120 € | 132 € |
| 7 Kg/cm ² | Ref. | 337241 | 337246 | 337252 | 337264 | 337272 | 337284 | 337296 |
| | Price | 3 970 € | 4 564 € | 5 334 € | 5 919 € | 6 544 € | 7 631 € | 9 236 € |
| | Δ 100 mm | 48 € | 63 € | 65 € | 94 € | 121 € | 153 € | 187 € |
| Recomended! | Sightglass | +255 € | +255 € | +255 € | +320 € | +320 € | +320 € | +375 € |
| Minimum C for manhole | | 924 | 928 | 928 | 974 | 965 | 965 | 1082 |
| Maximum C for 1 cylinder | | Table valid for calculation up to 2500 mm | | | | | | |

We can manufacture filters for higher cylindrical height (please check with us)

DCP SERIES Ø 415-960

DCP SERIES

Manufactured and calculated according to EN 13121-3.
 Material: Hand lay-up polyester with fiberglass (max quality polyester tech).
 Steel reinforced GRP vessel.
 All threaded connections are part of the structure of the filter in GRP.
 Closed legs & part of the filter structure.
 Top & bottom access.
 Design temperature 40°C.
 Bottom nozzle plate distribution.
 Top distributor according to the media/application.
 Tested 1.5 times design pressure

ADDITIONAL OPTIONS

Higher temperatures. (Ask us)
 High-chemical resistance. (Ask us) [See page 31](#)
 Cylindrical height ad-hoc. **(Check below)**
 Flange connections available. [See page 31](#)
 Additional sight glass. [See page 31](#)
 Anchorage system to ground. [See page 31](#)
 Seismic calculations. (Ask us)
 Drinking water / Food contact. (Ask us)

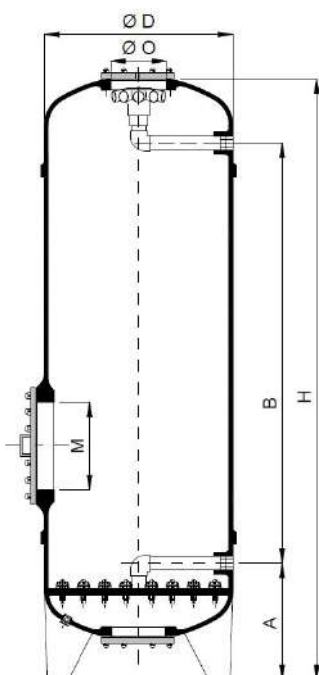

Type 1

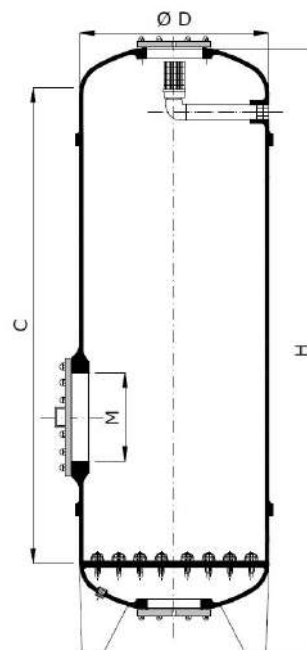

Type 2



Threaded connections Plastized Manhole lid Steel ARMORED Nozzle plate Nozzle plate detail Diffuser according to application Optional sightglass Standard Top lid Optional flanges Customizable height

| Design Pressure | | DCP-415 C=1500 H=1856 | DCP-460 C=1500 H=1867 | DCP-520 C=1500 H=1887 | DCP-640 C=1500 H=1941 | DCP-720 C=1500 H=2010 | DCP-840 C=1500 H=2090 | DCP-960 C=1500 H=2168 |
|--------------------------|------------|---|-----------------------------|-----------------------------|-----------------------------|-----------------------------|-----------------------------|-----------------------------|
| 2.5 Kg /cm ² | Ref. | 342141 | 342146 | 342152 | 342164 | 342172 | 342184 | 342196 |
| | Price | 3 435 € | 3 867 € | 4 491 € | 5 108 € | 5 656 € | 6 707 € | 8 296 € |
| | Δ 100 mm | 26 € | 33 € | 44 € | 57 € | 68 € | 90 € | 95 € |
| 5 Kg /cm ² | Ref. | 345141 | 345146 | 345152 | 345164 | 345172 | 345184 | 345196 |
| | Price | 3 917 € | 4 430 € | 5 158 € | 5 845 € | 6 509 € | 7 707 € | 9 505 € |
| | Δ 100 mm | 40 € | 54 € | 63 € | 78 € | 95 € | 128 € | 141 € |
| 7 Kg /cm ² | Ref. | 347141 | 347146 | 347152 | 347164 | 347172 | 347184 | 347196 |
| | Price | 4 543 € | 5 178 € | 6 116 € | 6 826 € | 7 592 € | 9 034 € | 11 048 € |
| | Δ 100 mm | 51 € | 67 € | 70 € | 101 € | 129 € | 164 € | 200 € |
| Recommended! | Sightglass | +255 € | +255 € | +255 € | +320 € | +320 € | +320 € | +375 € |
| Minimum C for manhole | | 924 | 928 | 928 | 974 | 965 | 965 | 1082 |
| Maximum C for 1 cylinder | | Table valid for calculation up to 2500 mm | | | | | | |

We can manufacture filters for higher cylindrical height (please check with us)

DPP SERIES Ø 415-960

DPP SERIES

Manufactured and calculated according to EN 13121-3.
 Material: Hand lay-up polyester with fiberglass (max quality polyester tech).
 Steel reinforced GRP vessel.
 All threaded connections are part of the structure of the filter in GRP.
 Closed legs & part of the filter structure.
 Top & bottom access.
 Design temperature 40°C.
 Bottom nozzle plate distribution.
 Top nozzle plate distribution.
 Tested 1.5 times design pressure
 Resin transfer flanges DN65 included

ADDITIONAL OPTIONS

Higher temperatures. (Ask us)
 High-chemical resistance. (Ask us) [See page 31](#)
 Cylindrical height ad-hoc. [\(Check below\)](#)
 Flange connections available. [See page 31](#)
 Additional sight glass. [See page 31](#)
 Anchorage system to ground. [See page 31](#)
 Seismic calculations. (Ask us)
 Drinking water / Food contact. (Ask us)

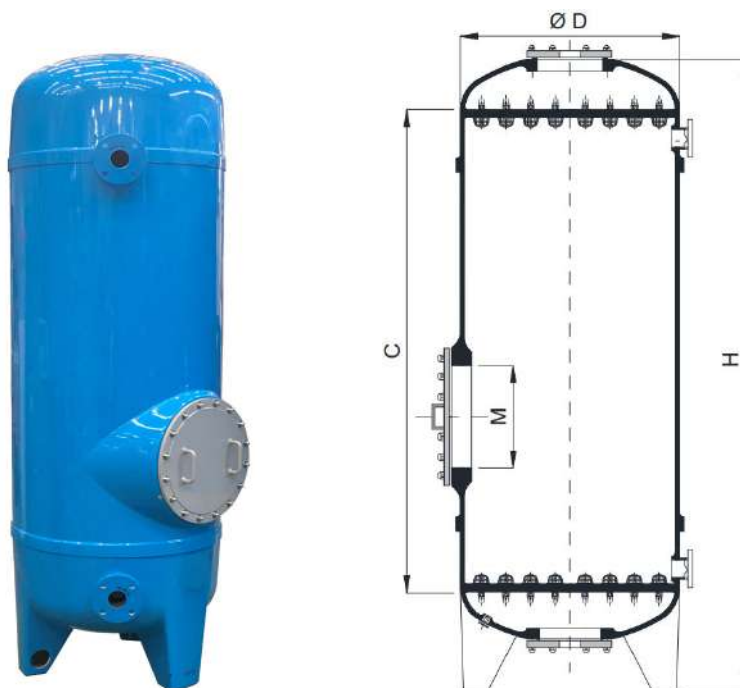

DN80 Flanges Load/Unload Included Plastiziced Manhole lid 2 x Steel ARMORED Nozzle plate Nozzle plate detail Optional sightglass Standard INLET OUTLET Optional INLET OUTLET Customizable height

| Design Pressure | | DPP-415 C=1500 H=1945 | DPP-460 C=1500 H=1955 | DPP-520 C=1500 H=1965 | DPP-640 C=1500 H=2015 | DPP-720 C=1500 H=2010 | DPP-840 C=1500 H=2090 | DPP-960 C=1500 H=2140 |
|--------------------------|------------|---|-----------------------------|-----------------------------|-----------------------------|-----------------------------|-----------------------------|-----------------------------|
| 2.5 Kg /cm ² | Ref. | 342241 | 342246 | 342252 | 342264 | 342272 | 342284 | 342296 |
| | Price | 4 508 € | 4 981 € | 5 772 € | 6 514 € | 7 205 € | 8 608 € | 10 607 € |
| | Δ 100 mm | 26 € | 33 € | 44 € | 57 € | 68 € | 90 € | 95 € |
| 5 Kg /cm ² | Ref. | 345241 | 345246 | 345252 | 345264 | 345272 | 345284 | 345296 |
| | Price | 4 991 € | 5 545 € | 6 441 € | 7 251 € | 8 057 € | 9 609 € | 11 815 € |
| | Δ 100 mm | 40 € | 54 € | 63 € | 78 € | 95 € | 128 € | 141 € |
| 7 Kg /cm ² | Ref. | 347241 | 347246 | 347252 | 347264 | 347272 | 347284 | 347296 |
| | Price | 5 617 € | 6 292 € | 7 396 € | 8 232 € | 9 140 € | 10 936 € | 13 359 € |
| | Δ 100 mm | 51 € | 67 € | 70 € | 101 € | 129 € | 164 € | 200 € |
| Recomended! | Sightglass | +255 € | +255 € | +255 € | +320 € | +320 € | +320 € | +375 € |
| Minimum C for manhole | | 835 | 840 | 850 | 900 | 965 | 965 | 1110 |
| Maximum C for 1 cylinder | | Table valid for calculation up to 2500 mm | | | | | | |

We can manufacture filters for higher cylindrical height (please check with us)

FB SERIES Ø 1010-3000

FB SERIES

Manufactured and calculated according to EN 13121-3.
 Material: Hand lay-up polyester with fiberglass (max quality polyester tech).
 Steel reinforced GRP vessel.
 Flanged connections for INLET/OUTLET.
 All connections are part of the structure of the filter in GRP.
 Closed legs & part of the filter structure.
 Side manhole & elliptical top manhole.
 Design temperature 40°C.
 Laterals distribution.
 Tested 1.5 times design pressure
 Sightglass included. (ALWAYS)

ADDITIONAL OPTIONS

Higher temperatures. (Ask us)
 High-chemical resistance. (Ask us) [See page 31](#)
 Additional sight glass. [See page 31](#)
 Anchorage system to ground. [See page 31](#)
 Seismic calculations. (Ask us)
 Drinking water / Food contact. (Ask us)
BESGO READY FILTERS "B" IN RED [See below](#)
 BESGO valves [See page 34](#)

WHY FB SERIES?

FB SERIES filters are a consequence of our molds design. This filter is the solution for a lower budget without compromising manufacturing quality, with a reasonable bed height and very proper internal distribution.

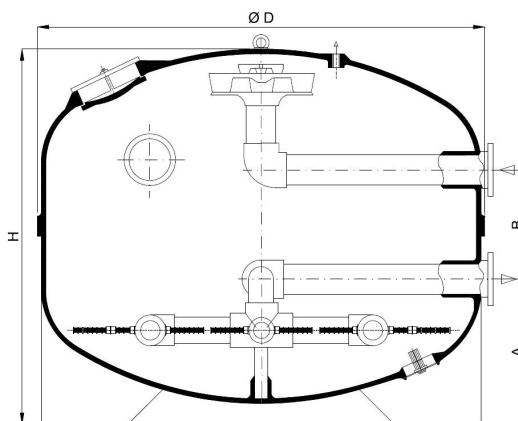

Flanged connections GRP Elliptical manhole lid Arms collector 0.3 mm Diffuser for Sand / AFM **ALWAYS** with sightglass Emptying access **Besgo ready!*** Ø1010-2040

| Design Pressure | | FB-40 Ø1010 H=1200 | FB-50 Ø1160 H=1300 | FB-60 Ø1260 H=1350 | FB-80 Ø1440 H=1470 | FB-100 Ø1640 H=1670 | FB-125 Ø1840 H=1760 | FB-150 Ø2040 H=1870 | FB-175 Ø2210 H=1990 | FB-200 Ø2340 H=2000 | FB-250 Ø2550 H=2070 | FB-300 Ø2800 H=2200 | FB-350 Ø3000 H=2090 |
|------------------------|-------|--------------------------------|--------------------------------|---------------------------------|---------------------------------|---------------------------------|---------------------------------|---------------------------------|---------------------------|---------------------------|---------------------------|---------------------------|-----------------------------|
| 2.5 Kg/cm ² | Ref. | 232010 | 232011 | 232012 | 232014 | 232016 | 232018 | 232020 | 232022 | 232023 | 232025 | 232028 | 232030 |
| | Price | 4 585 € | 5 065 € | 5 755 € | 6 670 € | 8 760 € | 10 760 € | 13 105 € | 14 700 € | 16 330 € | 18 815 € | 21 400 € | 24 710 € |
| 4 Kg/cm ² | Ref. | 314010 | 314011 | 314012 | 314014 | 314016 | 314018 | 314020 | 314022 | 314023 | 314025 | 314028 | 314030 |
| | Price | 6 131 € | 7 004 € | 8 076 € | 9 619 € | 12 982 € | 15 505 € | 18 692 € | 21 214 € | 22 468 € | 27 819 € | 32 905 € | 35 324 € |
| 5 Kg/cm ² | Ref. | 315010 | 315011 | 315012 | 315014 | 315016 | 315018 | 315020 | 315022 | 315023 | 315025 | 315028 | 315030 |
| | Price | 7 118 € | 7 789 € | 9 001 € | 10 770 € | 13 858 € | 17 171 € | 20 548 € | 24 313 € | 26 458 € | 31 969 € | 35 518 € | 42 914 € |
| 6 Kg/cm ² | Ref. | 316010 | 316011 | 316012 | 316014 | 316016 | 316018 | 316020 | 316022 | 316023 | 316025 | 316028 | 316030 |
| | Price | 7 616 € | 8 301 € | 9 865 € | 11 460 € | 15 026 € | 18 431 € | 23 553 € | 29 058 € | 31 179 € | 36 361 € | 42 251 € | 47 763 € |
| Flanges | | DN80 A=500 B=300* | DN80 A=550 B=300* | DN100 A=550 B=400* | DN100 A=625 B=400* | DN125 A=720 B=450* | DN125 A=740 B=450* | DN150 A=725 B=450* | DN200 A=760 B=605 | DN200 A=765 B=600 | DN250 A=760 B=700 | DN250 A=850 B=650 | DN250 A=check B=check |
| Media height * | | 500 | 600 | 650 | 720 | 800 | 850 | 900 | 1000 | 1000 | 1000 | 1000 | 900 |

* Media height recommended calculated based on ~ 30% expansion on distance between laterals and top distribution

D SERIES Ø 1010-3000

D SERIES

Manufactured and calculated according to EN 13121-3.
 Material: Hand lay-up polyester with fiberglass (max quality polyester tech).
 Steel reinforced GRP vessel.
 Flanged connections for INLET/OUTLET.
 All connections are part of the structure of the filter in GRP.
 Closed legs & part of the filter structure.
 Elliptical top manhole.
 Design temperature 40°C.
 Laterals distribution.
 Tested 1.5 times design pressure

ADDITIONAL OPTIONS

Higher temperatures. (Ask us)
 High-chemical resistance. (Ask us) [See page 31](#)
 Cylindrical height ad-hoc. ([Check below](#))
 Additional sight glass. [See page 31](#)
 Anchorage system to ground. [See page 31](#)
 Seismic calculations. (Ask us)
 Drinking water / Food contact. (Ask us)

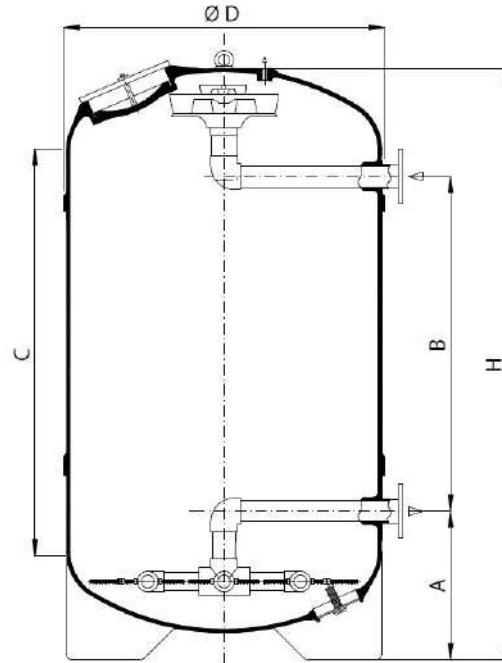

Flanged connections GRP Elliptical manhole lid Arms collector 0.3 mm Diffuser for Sand / AFM Diffuser for Ionic Exchange Optional sightglass Emptying access Customizable height

| Design Pressure | | D-1010 C=1500 H=2000 | D-1160 C=1500 H=2060 | D-1260 C=1500 H=2100 | D-1440 C=1500 H=2180 | D-1640 C=1500 H=2260 | D-1840 C=1500 H=2340 | D-2040 C=1500 H=2410 | D-2210 C=1500 H=2510 | D-2340 C=1500 H=2530 | D-2550 C=1500 H=2600 | D-2800 C=1500 H=2800 | D-3000 C=1500 H=2760 |
|------------------------|----------|----------------------------|----------------------------|----------------------------|----------------------------|----------------------------|----------------------------|----------------------------|----------------------------|----------------------------|----------------------------|----------------------------|----------------------------|
| 2.5 Kg/cm ² | Ref. | 352110 | 352111 | 352112 | 352114 | 352116 | 352118 | 352120 | 352122 | 352123 | 352125 | 352128 | 352130 |
| | Price | 6 343 € | 7 402 € | 7 996 € | 9 728 € | 12 590 € | 15 396 € | 18 118 € | 19 571 € | 21 632 € | 26 003 € | 28 111 € | 32 640 € |
| | Δ 100 mm | 154 € | 164 € | 249 € | 319 € | 354 € | 372 € | 384 € | 395 € | 420 € | 495 € | 636 € | 858 € |
| 4 Kg/cm ² | Ref. | 354110 | 354111 | 354112 | 354114 | 354116 | 354118 | 354120 | 354122 | 354123 | 354125 | 354128 | 354130 |
| | Price | 7 604 € | 8 716 € | 10 084 € | 12 061 € | 15 741 € | 18 669 € | 23 246 € | 25 409 € | 27 125 € | 33 307 € | 39 893 € | 42 733 € |
| | Δ 100 mm | 162 € | 167 € | 250 € | 325 € | 364 € | 395 € | 430 € | 450 € | 490 € | 560 € | 683 € | 903 € |
| 5 Kg/cm ² | Ref. | 355110 | 355111 | 355112 | 355114 | 355116 | 355118 | 355120 | 355122 | 355123 | 355125 | 355128 | 355130 |
| | Price | 8 811 € | 9 684 € | 11 067 € | 13 705 € | 17 262 € | 21 009 € | 25 621 € | 29 715 € | 32 060 € | 38 586 € | 44 310 € | 52 257 € |
| | Δ 100 mm | 178 € | 212 € | 280 € | 345 € | 401 € | 478 € | 504 € | 543 € | 580 € | 655 € | 783 € | 922 € |
| 6 Kg/cm ² | Ref. | 356110 | 356111 | 356112 | 356114 | 356116 | 356118 | 356120 | 356122 | 356123 | 356125 | 356128 | 356130 |
| | Price | 9 443 € | 10 423 € | 12 210 € | 14 798 € | 18 592 € | 22 470 € | 28 323 € | 34 299 € | 36 659 € | 42 987 € | 51 292 € | 59 417 € |
| | Δ 100 mm | 198 € | 242 € | 299 € | 349 € | 459 € | 550 € | 620 € | 650 € | 690 € | 750 € | 816 € | 945 € |

Recommended! Sightglass +375 € +375 € +375 € +375 € +455 € +455 € +540 € +540 € +540 € +540 € +540 € +540 €

Minimum C

D Series can be reduced up to FB model

| | | | | | | | | | | | | |
|--------------------------|------|------|------|------|------|------|------|------|------|------|------|------|
| Maximum C for 1 cylinder | 2310 | 2350 | 2345 | 2390 | 2510 | 2520 | 2640 | 2580 | 2570 | 2650 | 2570 | 2510 |
|--------------------------|------|------|------|------|------|------|------|------|------|------|------|------|

We can manufacture filters for higher cylindrical height (please check with us)

DC SERIES Ø 1010-3000

DC SERIES

Manufactured and calculated according to EN 13121-3.
 Material: Hand lay-up polyester with fiberglass (max quality polyester tech).
 Steel reinforced GRP vessel.
 Flanged connections for INLET/OUTLET.
 All connections are part of the structure of the filter in GRP.
 Closed legs & part of the filter structure.
 Side manhole & elliptical top manhole.
 Design temperature 40°C.
 Laterals distribution.
 Tested 1.5 times design pressure

ADDITIONAL OPTIONS

Higher temperatures. (Ask us)
 High-chemical resistance. (Ask us) [See page 31](#)
 Cylindrical height ad-hoc. ([Check below](#))
 Additional sight glass. [See page 31](#)
 Anchorage system to ground. [See page 31](#)
 Seismic calculations. (Ask us)
 Drinking water / Food contact. (Ask us)
 Lateral manhole Ø500 mm.

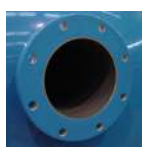
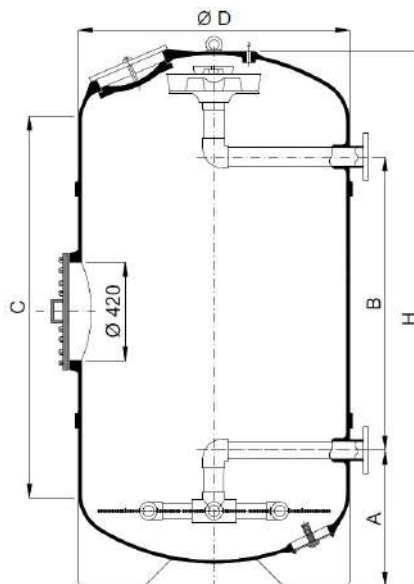

Flanged connections

Plastized Manhole lid

GRP Elliptical manhole lid

Arms collector 0.3 mm

Diffuser for Sand / AFM

Diffuser for Ionic Exchange

Optional sightglass

Emptying access

Customizable height

| Design Pressure | | DC-1010 | DC-1160 | DC-1260 | DC-1440 | DC-1640 | DC-1840 | DC-2040 | DC-2210 | DC-2340 | DC-2550 | DC-2800 | DC-3000 |
|--------------------------|------------|------------------|------------------|------------------|------------------|------------------|------------------|------------------|------------------|------------------|------------------|------------------|------------------|
| | | C=1500 H=2000 | C=1500 H=2060 | C=1500 H=2100 | C=1500 H=2180 | C=1535 H=2295 | C=1565 H=2405 | C=1605 H=2515 | C=1830 H=2840 | C=1820 H=2850 | C=1820 H=2920 | C=1740 H=3040 | C=1810 H=3070 |
| 2.5 Kg/cm ² | Ref. | 352210 | 352211 | 352212 | 352214 | 352216 | 352218 | 352220 | 352222 | 352223 | 352225 | 352228 | 352230 |
| | Price | 8 248 € | 9 322 € | 9 915 € | 11 730 € | 14 716 € | 17 640 € | 20 820 € | 23 143 € | 25 316 € | 29 687 € | 32 435 € | 38 098 € |
| | Δ 100 mm | 154 € | 164 € | 249 € | 319 € | 354 € | 372 € | 384 € | 395 € | 420 € | 495 € | 636 € | 858 € |
| 4 Kg/cm ² | Ref. | 354110 | 354211 | 354212 | 354214 | 354216 | 354218 | 354220 | 354222 | 354223 | 354225 | 354228 | 354230 |
| | Price | 9 509 € | 10 635 € | 12 002 € | 14 063 € | 17 871 € | 20 923 € | 25 961 € | 29 033 € | 31 002 € | 37 421 € | 44 330 € | 48 329 € |
| | Δ 100 mm | 162 € | 167 € | 250 € | 325 € | 364 € | 395 € | 430 € | 450 € | 490 € | 560 € | 683 € | 903 € |
| 5 Kg/cm ² | Ref. | 355110 | 355211 | 355212 | 355214 | 355216 | 355218 | 355220 | 355222 | 355223 | 355225 | 355228 | 355230 |
| | Price | 10 715 € | 11 602 € | 12 986 € | 15 708 € | 19 406 € | 23 323 € | 28 449 € | 33 676 € | 36 194 € | 42 998 € | 48 988 € | 57 834 € |
| | Δ 100 mm | 178 € | 212 € | 280 € | 345 € | 401 € | 478 € | 504 € | 543 € | 580 € | 655 € | 783 € | 922 € |
| 6 Kg/cm ² | Ref. | 356210 | 356211 | 356212 | 356214 | 356216 | 356218 | 356220 | 356222 | 356223 | 356225 | 356228 | 356230 |
| | Price | 11 348 € | 12 341 € | 14 128 € | 16 802 € | 20 755 € | 24 880 € | 31 351 € | 38 415 € | 40 939 € | 47 451 € | 56 051 € | 65 147 € |
| | Δ 100 mm | 198 € | 242 € | 299 € | 349 € | 459 € | 550 € | 620 € | 650 € | 690 € | 750 € | 816 € | 945 € |
| Recomended! | Sightglass | +375 € | +375 € | +375 € | +375 € | +455 € | +455 € | +540 € | +540 € | +540 € | +540 € | +540 € | +540 € |
| Minimum C for manhole | | 1470 | 1510 | 1505 | 1495 | 1535 | 1565 | 1605 | 1830 | 1820 | 1820 | 1740 | 1810 |
| Maximum C for 1 cylinder | | 2310 | 2350 | 2345 | 2390 | 2510 | 2520 | 2640 | 2580 | 2570 | 2650 | 2570 | 2510 |

We can manufacture filters for higher cylindrical height (please check with us)

DP SERIES Ø 1010-3000

DP SERIES

Manufactured and calculated according to EN 13121-3.
 Material: Hand lay-up polyester with fiberglass (max quality polyester tech).
 Steel reinforced GRP vessel.
 Flanged connections for INLET/OUTLET
 All connections are part of the structure of the filter in GRP.
 Closed legs & part of the filter structure.
 Side manhole & elliptical top manhole.
 Design temperature 40°C.
 Nozzle plate. (GRP + Steel)
 Tested 1.5 times design pressure

ADDITIONAL OPTIONS

Higher temperatures. (Ask us)
 High-chemical resistance. (Ask us) [See page 31](#)
 Cylindrical height ad-hoc.
 Additional sight glass. [See page 31](#)
 Anchorage system to ground. [See page 31](#)
 Seismic calculations. (Ask us)
 Drinking water / Food contact. (Ask us)
 Lateral manhole Ø500 mm.
Shorter cylinder with Ø200mm hand hole Solution

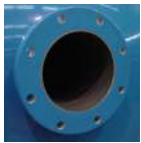
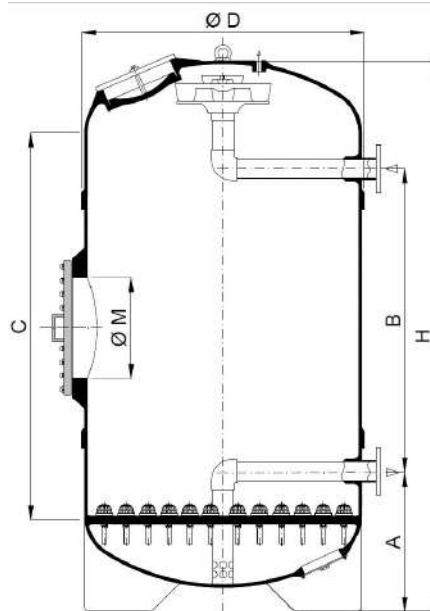

Flanged connections

Plastitized Manhole lid

GRP Elliptical manhole lid

Steel ARMORED Nozzle plate

Diffuser for Sand / AFM

Diffuser for Ionic Exchange

Optional sightglass

Emptying access

Customizable height

| Design Pressure | | DP-1010 C=1500 H=2090 | DP-1160 C=1500 H=2150 | DP-1260 C=1500 H=2180 | DP-1440 C=1500 H=2290 | DP-1640 C=1500 H=2370 | DP-1840 C=1500 H=2450 | DP-2040 C=1500 H=2515 | DP-2210 C=1735 H=2840 | DP-2340 C=1730 H=2850 | DP-2550 C=1730 H=2920 | DP-2800 C=1710 H=3040 | DP-3000 C=1760 H=3070 |
|------------------------|--------------------------|-----------------------------|-----------------------------|-----------------------------|-----------------------------|-----------------------------|-----------------------------|-----------------------------|-----------------------------|-----------------------------|-----------------------------|-----------------------------|-----------------------------|
| 2.5 Kg/cm ² | Ref. | 362110 | 362111 | 362112 | 362114 | 362116 | 362118 | 362120 | 362122 | 362123 | 362125 | 362128 | 362130 |
| | Price | 10 440 € | 12 155 € | 13 361 € | 15 757 € | 19 859 € | 23 295 € | 28 201 € | 31 917 € | 34 438 € | 40 491 € | 46 512 € | 54 023 € |
| | Δ 100 mm | 154 € | 164 € | 249 € | 319 € | 354 € | 372 € | 384 € | 395 € | 420 € | 495 € | 636 € | 858 € |
| 4 Kg/cm ² | Ref. | 364110 | 364111 | 364112 | 364114 | 364116 | 364118 | 364120 | 364122 | 364123 | 364125 | 364128 | 364130 |
| | Price | 11 702 € | 13 467 € | 15 449 € | 18 089 € | 23 011 € | 26 568 € | 33 328 € | 37 791 € | 40 069 € | 48 104 € | 58 394 € | 64 232 € |
| | Δ 100 mm | 162 € | 167 € | 250 € | 325 € | 364 € | 395 € | 430 € | 450 € | 490 € | 560 € | 683 € | 903 € |
| 5 Kg/cm ² | Ref. | 365110 | 365111 | 365112 | 365114 | 365116 | 365118 | 365120 | 365122 | 365123 | 365125 | 365128 | 365130 |
| | Price | 12 908 € | 14 434 € | 16 433 € | 19 734 € | 24 532 € | 28 908 € | 35 703 € | 42 338 € | 45 188 € | 53 597 € | 63 021 € | 73 739 € |
| | Δ 100 mm | 178 € | 212 € | 280 € | 345 € | 401 € | 478 € | 504 € | 543 € | 580 € | 655 € | 783 € | 922 € |
| 6 Kg/cm ² | Ref. | 366110 | 366111 | 366112 | 366114 | 366116 | 366118 | 366120 | 366122 | 366123 | 366125 | 366128 | 366130 |
| | Price | 13 540 € | 15 175 € | 17 576 € | 20 829 € | 25 862 € | 30 368 € | 38 406 € | 47 032 € | 49 893 € | 58 036 € | 70 074 € | 81 028 € |
| | Δ 100 mm | 198 € | 242 € | 299 € | 349 € | 459 € | 550 € | 620 € | 650 € | 690 € | 750 € | 816 € | 945 € |
| Recomended! | Sightglass | +375 € | +375 € | +375 € | +375 € | +455 € | +455 € | +540 € | +540 € | +540 € | +540 € | +540 € | +540 € |
| | Minimum C for manhole | 1380 | 1420 | 1425 | 1385 | 1425 | 1455 | 1500 | 1735 | 1730 | 1730 | 1710 | 1760 |
| | Maximum C for 1 cylinder | 2220 | 2260 | 2265 | 2280 | 2400 | 2410 | 2535 | 2485 | 2480 | 2560 | 2540 | 2460 |



We can manufacture filters for higher cylindrical height (please check with us)

HORIZONTAL FILTERS (Ø1840 - 3000)

HORIZONTAL SERIES

Manufactured and calculated according to EN 13121-3.
 Material: Hand lay-up polyester with fiberglass (max quality polyester tech).
 Steel reinforced GRP vessel.
 Flanged connections for INLET/OUTLET.
 All connections are part of the structure of the filter in GRP.
 Supports for the filter included (2 or 3 according to model).
 2 x elliptical top manhole.
 Sightglass included.
 Design temperature 40°C.
 Laterals distribution.
 Tested 1.5 times design pressure

ADDITIONAL OPTIONS

Customizable length if necessary.
 Air backwash distribution. (Ask us) 
 Higher temperatures. (Ask us)
 High-chemical resistance. (Ask us) [See page 31](#)
 Additional sight glass. [See page 31](#)
 Anchorage system to ground. [See page 31](#)
 Flange connections in the dome. (Ask us) 
 Seismic calculations. (Ask us)
 Drinking water / Food contact. (Ask us)
 Additional flanges. [See page 31](#)

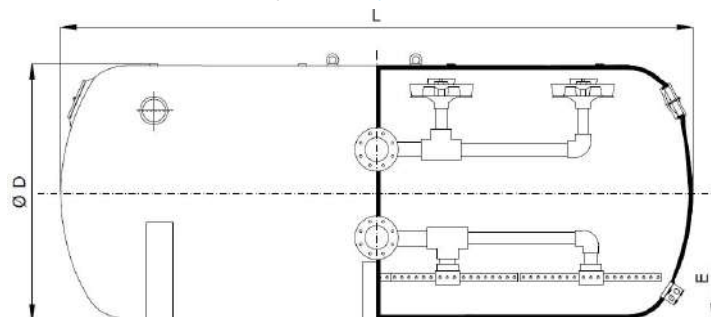
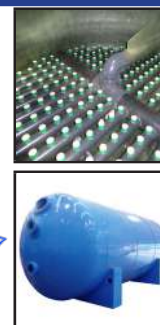

Flanged connections Optional Plastized Manhole lid 2 x GRP Elliptical manhole lid Arms collector 0.3 mm Diffuser for Sand / AFM Diffuser for Active Carbon ALWAYS with sightglass Emptying access Separated supports

| Ø | Total Length | Filtering Surface | AFM (G3/Rest) | Supports | Ref. | 2,5 Kg/cm ² | Ref. | 4 Kg/cm ² | Ref. | 5 Kg/cm ² | Ref. | 6 Kg/cm ² |
|------|---------------|----------------------|---------------|----------|--------|------------------------|--------|----------------------|--------|----------------------|--------|----------------------|
| 1840 | 3100 | 5,22 m ² | 1,1 4,2 | 2 | 322118 | 20 395 € | 324118 | 31 413 € | 325118 | 34 636 € | 326118 | 40 825 € |
| | 3900 | 6,50 m ² | 1,3 5,6 | 2 | 322218 | 25 295 € | 324218 | 37 343 € | 325218 | 45 387 € | 326218 | 50 092 € |
| | 4700 | 8,11 m ² | 1,5 6,8 | 3 | 322318 | 30 890 € | 324318 | 45 156 € | 325318 | 52 330 € | 326318 | 60 458 € |
| | 5500 | 9,55 m ² | 1,8 8,1 | 3 | 322418 | 33 880 € | 324418 | 52 349 € | 325418 | 60 770 € | 326418 | 70 349 € |
| | 6300 | 11,11 m ² | 2,1 9,4 | 3 | 322518 | 40 180 € | 324518 | 59 485 € | 325518 | 69 664 € | 326518 | 80 384 € |
| 2040 | 3360 | 6,50 m ² | 1,1 7,3 | 2 | 322120 | 25 135 € | 324120 | 35 271 € | 325120 | 40 827 € | 326120 | 47 957 € |
| | 4160 | 8,00 m ² | 1,5 8,2 | 2 | 322220 | 30 045 € | 324220 | 42 608 € | 325220 | 48 332 € | 326220 | 58 846 € |
| | 4960 | 9,50 m ² | 1,7 10 | 3 | 322320 | 35 890 € | 324320 | 51 419 € | 325320 | 59 196 € | 326320 | 68 794 € |
| | 5660 | 11,00 m ² | 2 11,3 | 3 | 322420 | 40 845 € | 324420 | 59 296 € | 325420 | 67 304 € | 326420 | 79 867 € |
| | 6460 | 12,70 m ² | 2,3 13,3 | 3 | 322520 | 45 655 € | 324520 | 66 016 € | 325520 | 77 359 € | 326520 | 90 297 € |
| 2210 | 3400 | 7,08 m ² | 1,3 7,8 | 2 | 322122 | 28 530 € | 324122 | 40 009 € | 325122 | 47 150 € | 326122 | 55 496 € |
| | 4170 | 8,80 m ² | 1,5 10 | 2 | 322222 | 33 045 € | 324222 | 48 114 € | 325222 | 55 269 € | 326222 | 65 143 € |
| | 5000 | 10,70 m ² | 2 11,7 | 3 | 322322 | 39 150 € | 324322 | 57 462 € | 325322 | 65 931 € | 326322 | 76 249 € |
| | 5720 | 12,40 m ² | 2,2 13,8 | 3 | 322422 | 44 165 € | 324422 | 65 799 € | 325422 | 74 712 € | 326422 | 86 936 € |
| | 6500 | 14,20 m ² | 2,5 15,8 | 3 | 322522 | 49 165 € | 324522 | 73 511 € | 325522 | 84 506 € | 326522 | 96 923 € |
| 2340 | 3520 | 7,40 m ² | 1,5 8,5 | 2 | 322123 | 31 240 € | 324123 | 43 782 € | 325123 | 52 334 € | 326123 | 61 694 € |
| | 4300 | 9,30 m ² | 1,8 11 | 2 | 322223 | 35 245 € | 324223 | 52 456 € | 325223 | 60 870 € | 326223 | 69 865 € |
| | 5100 | 11,20 m ² | 2,1 13,2 | 3 | 322323 | 41 465 € | 324323 | 62 117 € | 325323 | 71 072 € | 326323 | 81 864 € |
| | 5800 | 13,00 m ² | 2,5 15 | 3 | 322423 | 46 415 € | 324423 | 70 712 € | 325423 | 80 314 € | 326423 | 91 908 € |
| | 6600 | 15,00 m ² | 2,8 17,3 | 3 | 322523 | 51 485 € | 324523 | 79 228 € | 325523 | 89 614 € | 326523 | 101 207 € |
| 2550 | 3450 | 8,00 m ² | 2,2 9,1 | 2 | 322125 | 33 830 € | 324125 | 48 487 € | 325125 | 58 107 € | 326125 | 69 159 € |
| | 4350 | 10,00 m ² | 3 12 | 2 | 322225 | 39 200 € | 324225 | 58 358 € | 325225 | 68 493 € | 326225 | 79 649 € |
| | 5150 | 12,30 m ² | 3,5 14,5 | 3 | 322325 | 45 590 € | 324325 | 69 433 € | 325325 | 79 989 € | 326325 | 92 092 € |
| | 6000 | 14,40 m ² | 4,2 17 | 3 | 322425 | 50 920 € | 324425 | 79 197 € | 325425 | 89 212 € | 326425 | 103 188 € |
| | 6850 | 16,50 m ² | 5 20 | 3 | 322525 | 56 205 € | 324525 | 89 236 € | 325525 | 100 598 € | 326525 | 115 132 € |
| 2800 | 3680 | 9,30 m ² | 2,5 12,5 | 2 | 322128 | 37 045 € | 324128 | 57 521 € | 325128 | 68 918 € | 326128 | 83 120 € |
| | 4500 | 11,60 m ² | 3,5 15,5 | 2 | 322228 | 46 535 € | 324228 | 68 960 € | 325228 | 81 049 € | 326228 | 94 133 € |
| | 5360 | 14,00 m ² | 4 18,5 | 3 | 322328 | 53 040 € | 324328 | 80 684 € | 325328 | 93 559 € | 326328 | 108 056 € |
| | 6230 | 16,40 m ² | 4,5 22,5 | 3 | 322428 | 59 130 € | 324428 | 91 995 € | 325428 | 104 910 € | 326428 | 119 935 € |
| | 7040 | 18,50 m ² | 5,2 26 | 3 | 322528 | 65 640 € | 324528 | 100 196 € | 325528 | 115 200 € | 326528 | 131 856 € |
| 3000 | Ask for price | | | | | | | | | | | |

CARTRIDGE FILTERS

CARTRIDGE FILTER

Design pressure 6 Kg/cm²
 Steel reinforced GRP vessel.
 Material: Hand lay-up polyester with fiberglass (max quality polyester tech).
 Manufactured and calculated according to EN 13121-3.
 All connections are part of the structure of the filter in GRP.
 Design temperature 40°C.
 PVC pipes inside threaded to plate to insert Cartridges.
 Tested 1.5 times design pressure

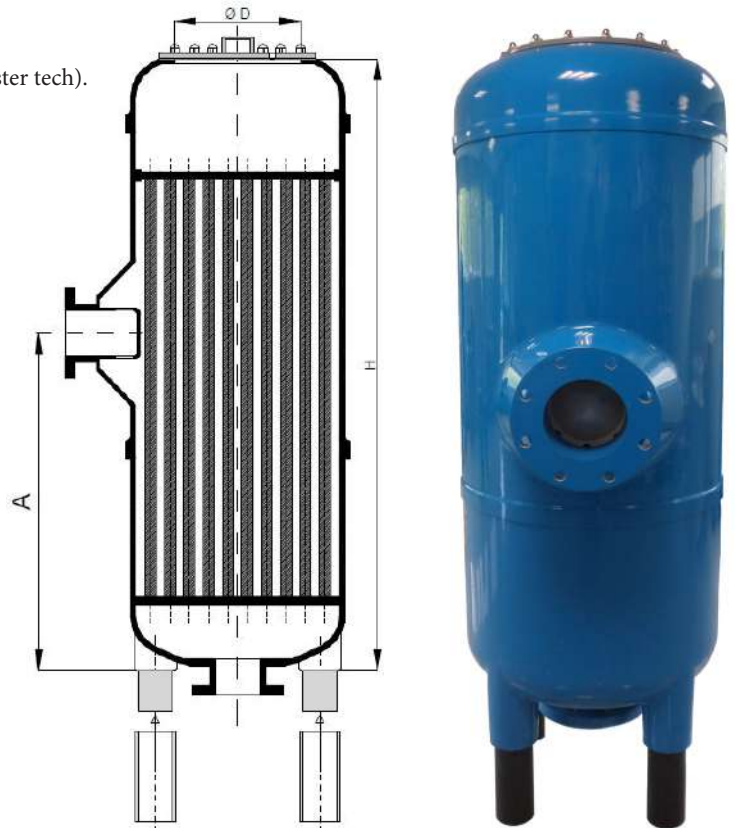
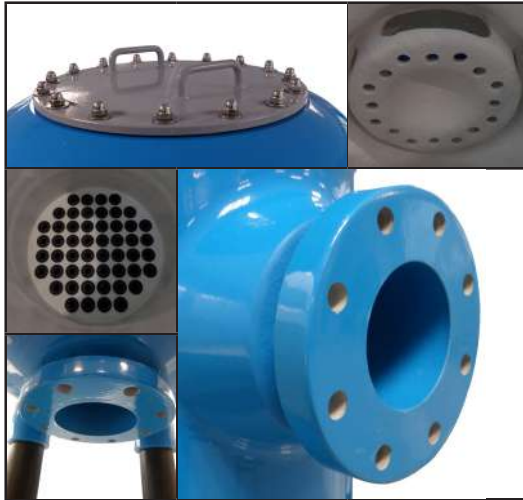

| Model | CF-330/30 Ø330 | CF-415/30 Ø415 | CF-520/30 Ø520 | CF-640/30 Ø640 |
|-------------------|------------------------------|------------------------------|------------------------------|-------------------------------|
| N° Cartridges | 14 | 21 | 32 | 52 |
| Ref | 436303 | 436304 | 436305 | 436306 |
| Length Cartridges | 30" (28.1 m ³ /h) | 30" (42.2 m ³ /h) | 30" (64.3 m ³ /h) | 30" (104.5 m ³ /h) |
| Price | 4 408 € | 7 078 € | 8 058 € | 10 323 € |

| Model | CF-330/40 Ø330 | CF-415/40 Ø415 | CF-520/40 Ø520 | CF-640/40 Ø640 |
|-------------------|------------------------------|------------------------------|------------------------------|-------------------------------|
| N° Cartridges | 14 | 21 | 32 | 52 |
| Ref | 436403 | 436404 | 436405 | 436406 |
| Length Cartridges | 40" (37.5 m ³ /h) | 40" (56.2 m ³ /h) | 40" (85.7 m ³ /h) | 40" (139.3 m ³ /h) |
| Price | 4 530 € | 7 225 € | 8 228 € | 10 556 € |

Cartridges not included in the price!



TwinPure 4 layers is a new cartridge filter, manufactured with 4 different filtration layers. The patented multilayer configuration has the benefits of a deep filtration. TwinPure 4 layers has been designed without internal soul and with a high particle retention capacity and a lower initial differential pressure. The 4 layers with different micron sizes allows increase the colloidal retention capacity and reduce the filtration costs.

It is recommended to replace the filtration element at 1,0-1,5 Bar.

*Recommended flow for
each 10" 0.67 m³/h*

| | 1 µ | 5 µ | 10 µ |
|-----|------|------|------|
| 30" | 22 € | 22 € | 22 € |
| 40" | 22 € | 22 € | 22 € |

KP SERIES Ø 1010-1840

KP SERIES

Manufactured and calculated according to EN 13121-3.
 Material: Hand lay-up polyester with fiberglass (max quality polyester tech).
 Steel reinforced GRP vessel.
 Flanged connections for INLET/OUTLET or PVC lid in the bottom.
 All connections are part of the structure of the filter in GRP.
 Closed legs & part of the filter structure.
 Side manhole & elliptical top manhole.
 Design temperature 40°C.
 Bottom nozzle plate. (GRP + Steel)
 Longer legs for bottom connection or complete drain.
 Tested 1.5 times design pressure

ADDITIONAL OPTIONS

Higher temperatures. (Ask us)
 High-chemical resistance. (Ask us) [See page 31](#)
 Cylindrical height ad-hoc. ([Check below](#))
 Additional sight glass. [See page 31](#)
 Additional flanges. [See page 31](#)
 Anchorage system to ground. [See page 31](#)
 Seismic calculations. (Ask us)
 Drinking water / Food contact. (Ask us)
 Lateral manhole Ø500 mm.

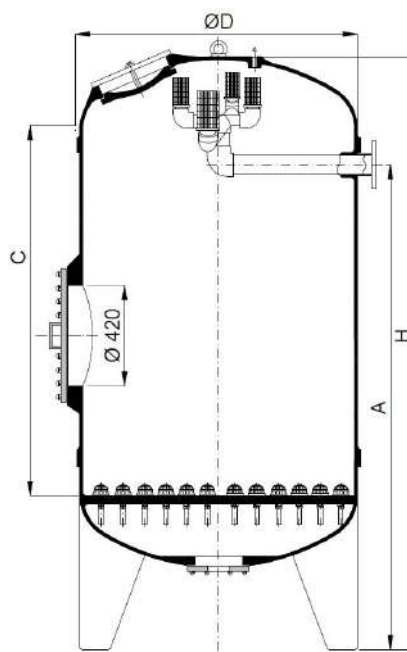

Flanged connections Plastized Manhole lid GRP Elliptical manhole lid Steel ARMORED Nozzle plate Optional Sightglass Diffuser for Ionic exchange Higher legs Optional bottom flange Customizable height

| Design Pressure | | KP-1010 C=1500 H=2290 | KP-1160 C=1500 H=2385 | KP-1260 C=1500 H=2435 | KP-1440 C=1500 H=2510 | KP-1640 C=1500 H=2570 | KP-1840 C=1500 H=2700 |
|--------------------------|------------|-----------------------------|-----------------------------|-----------------------------|-----------------------------|-----------------------------|-----------------------------|
| 2.5 Kg/cm ² | Ref. | 382110 | 382111 | 382112 | 382114 | 382116 | 382118 |
| | Price | 10 779 € | 12 491 € | 13 842 € | 16 393 € | 20 708 € | 24 246 € |
| | Δ 100 mm | 154 € | 164 € | 249 € | 319 € | 354 € | 372 € |
| 4 Kg/cm ² | Ref. | 384110 | 384111 | 384112 | 384114 | 384116 | 384118 |
| | Price | 12 021 € | 13 867 € | 15 997 € | 18 760 € | 23 963 € | 27 593 € |
| | Δ 100 mm | 162 € | 167 € | 250 € | 325 € | 364 € | 395 € |
| 5 Kg/cm ² | Ref. | 385110 | 385111 | 385112 | 385114 | 385116 | 385118 |
| | Price | 13 202 € | 14 831 € | 16 994 € | 20 410 € | 25 475 € | 30 092 € |
| | Δ 100 mm | 178 € | 212 € | 280 € | 345 € | 401 € | 478 € |
| 6 Kg/cm ² | Ref. | 386110 | 386111 | 386112 | 386114 | 386116 | 386118 |
| | Price | 13 932 € | 15 687 € | 18 465 € | 21 710 € | 26 980 € | 31 657 € |
| | Δ 100 mm | 198 € | 242 € | 299 € | 349 € | 459 € | 550 € |
| Recomended! | Sightglass | +375 € | +375 € | +375 € | +375 € | +455 € | +455 € |
| Minimum C for manhole | | 1355 | 1350 | 1325 | 1295 | 1265 | 1285 |
| Maximum C for 1 cylinder | | 2195 | 2190 | 2170 | 2190 | 2240 | 2240 |

We can manufacture filters for higher cylindrical height (please check with us)

KPP SERIES Ø 1010-1840

KPP SERIES

Manufactured and calculated according to EN 13121-3.
 Material: Hand lay-up polyester with fiberglass (max quality polyester tech).
 Steel reinforced GRP vessel.
 Flanged connections for INLET/OUTLET or PVC lids.
 All connections are part of the structure of the filter in GRP.
 Closed legs & part of the filter structure.
 Side manhole.
 Design temperature 40°C.
 Bottom nozzle plate (GRP + Steel)
 Top nozzle plate. (GRP + Steel)
 Longer legs for bottom connection or complete drain.
 Tested 1.5 times design pressure
 Resin transfer flanges DN80 included

ADDITIONAL OPTIONS

Higher temperatures. (Ask us)
 High-chemical resistance. (Ask us) [See page 31](#)
 Cylindrical height ad-hoc. ([Check below](#))
 Additional sight glass. [See page 31](#)
 Additional flanges. [See page 31](#)
 Anchorage system to ground. [See page 31](#)
 Seismic calculations. (Ask us)
 Drinking water / Food contact. (Ask us)
 Lateral manhole Ø500 mm.

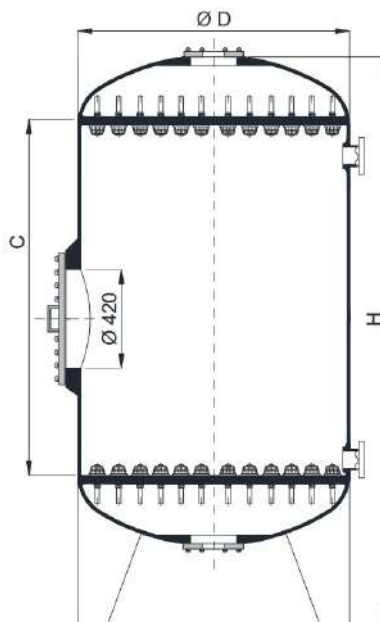

DN80 Flanges
Load/Unload
Included

Plastitized
Manhole lid

2 x Steel
ARMORED
Nozzle plate

Optional
Sightglass

Top connection
Standard

Higher legs

Optional
flanged
connections

Customizable
height

| Design Pressure | | KPP-1010 C=1500 H=2325 | KPP-1160 C=1500 H=2435 | KPP-1260 C=1500 H=2450 | KPP-1440 C=1500 H=2535 | KPP-1640 C=1500 H=2585 | KPP-1840 C=1500 H=2735 |
|------------------------|--------------------------|------------------------------|------------------------------|------------------------------|------------------------------|------------------------------|------------------------------|
| 2.5 Kg/cm ² | Ref. | 382210 | 382211 | 382212 | 382214 | 382216 | 382218 |
| | Price | 13 583 € | 16 035 € | 18 042 € | 21 370 € | 27 032 € | 31 612 € |
| | Δ 100 mm | 154 € | 164 € | 249 € | 319 € | 354 € | 372 € |
| 4 Kg/cm ² | Ref. | 384210 | 384211 | 384212 | 384214 | 384216 | 384218 |
| | Price | 14 826 € | 17 410 € | 20 198 € | 23 737 € | 30 286 € | 34 960 € |
| | Δ 100 mm | 162 € | 167 € | 250 € | 325 € | 364 € | 395 € |
| 5 Kg/cm ² | Ref. | 385210 | 385211 | 385212 | 385214 | 385216 | 385218 |
| | Price | 16 004 € | 18 375 € | 21 195 € | 25 387 € | 31 799 € | 37 457 € |
| | Δ 100 mm | 178 € | 212 € | 280 € | 345 € | 401 € | 478 € |
| 6 Kg/cm ² | Ref. | 386210 | 386211 | 386212 | 386214 | 386216 | 386218 |
| | Price | 16 736 € | 19 229 € | 22 667 € | 26 687 € | 33 305 € | 39 023 € |
| | Δ 100 mm | 198 € | 242 € | 299 € | 349 € | 459 € | 550 € |
| Recomended! | Sightglass | +375 € | +375 € | +375 € | +375 € | +455 € | +455 € |
| | Minimum C for manhole | 1320 | 1300 | 1310 | 1270 | 1250 | 1250 |
| | Maximum C for 1 cylinder | 2070 | 2050 | 2060 | 2020 | 2000 | 2000 |

We can manufacture filters for higher cylindrical height (please check with us)

DPC SERIES Ø 2040-3000

DPC SERIES

Manufactured and calculated according to EN 13121-3.
 Material: Hand lay-up polyester with fiberglass (max quality polyester tech).
 Steel reinforced GRP vessel.
 Flanged connections for INLET/OUTLET or PVC lid in the bottom.
 All connections are part of the structure of the filter in GRP.
 Closed legs & part of the filter structure.
 Side manhole & elliptical top manhole.
 Design temperature 40°C.
 Bottom nozzle plate (GRP + Steel).
 Leg extension for bottom connection (up to 500 mm) or complete drain.
 Tested 1.5 times design pressure

ADDITIONAL OPTIONS

Higher temperatures. (Ask us)
 High-chemical resistance. (Ask us) [See page 31](#)
 Cylindrical height ad-hoc. [\(Check below\)](#)
 Additional sight glass. [See page 31](#)
 Additional flanges. [See page 31](#)
 Anchorage system to ground. [See page 31](#)
 Seismic calculations. (Ask us)
 Drinking water / Food contact. (Ask us)
 Lateral manhole Ø500 mm.

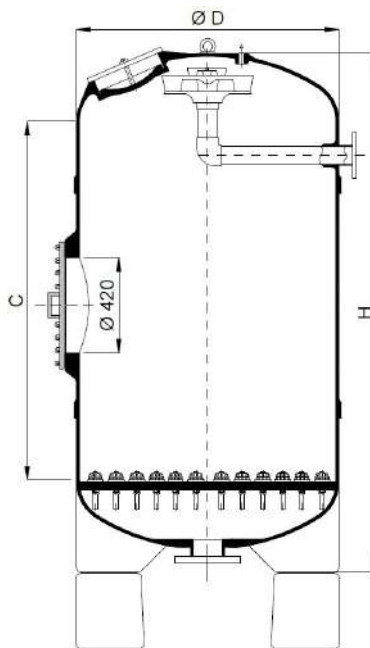

| | Flanged connections | Plastized Manhole lid | GRP Elliptical manhole lid | Steel ARMORED Nozzle plate | Optional sightglass | Diffuser for Ionic Exchange | Leg extension in GRP | Standard bottom flange | Customizable height |
|------------------------|---------------------------------|-----------------------|--------------------------------------|--------------------------------------|--------------------------------------|--------------------------------------|--------------------------------------|--------------------------------------|---------------------|
| Design Pressure | | | DPC-2040 C=1500 *H=2515 | DPC-2210 C=1735 *H=2840 | DPC-2340 C=1730 *H=2850 | DPC-2550 C=1730 *H=2920 | DPC-2800 C=1710 *H=3040 | DPC-3000 C=1760 *H=3070 | |
| 2.5 Kg/cm ² | Ref. | | 382120 | 382122 | 382123 | 382125 | 382128 | 382130 | |
| | Price | | 30 437 € | 34 152 € | 36 673 € | 42 726 € | 48 748 € | 56 260 € | |
| | Δ 100 mm | | 384 € | 395 € | 420 € | 495 € | 636 € | 858 € | |
| 4 Kg/cm ² | Ref. | | 384120 | 384122 | 384123 | 384125 | 384128 | 384130 | |
| | Price | | 35 565 € | 40 028 € | 42 305 € | 50 339 € | 60 629 € | 66 467 € | |
| | Δ 100 mm | | 430 € | 450 € | 490 € | 560 € | 683 € | 903 € | |
| 5 Kg/cm ² | Ref. | | 385120 | 385122 | 385123 | 385125 | 385128 | 385130 | |
| | Price | | 37 939 € | 44 574 € | 47 425 € | 55 834 € | 65 256 € | 75 975 € | |
| | Δ 100 mm | | 504 € | 543 € | 580 € | 655 € | 783 € | 922 € | |
| 6 Kg/cm ² | Ref. | | 386120 | 386122 | 386123 | 386125 | 386128 | 386130 | |
| | Price | | 40 642 € | 49 268 € | 52 129 € | 60 271 € | 72 311 € | 83 263 € | |
| | Δ 100 mm | | 620 € | 650 € | 690 € | 750 € | 816 € | 945 € | |
| Recommended! | Sightglass | | +540 € | +540 € | +540 € | +540 € | +540 € | +540 € | |
| | Minimum C for manhole | | 1500 | 1735 | 1730 | 1730 | 1710 | 1760 | |
| | Maximum C for 1 cylinder | | 2535 | 2485 | 2480 | 2560 | 2540 | 2460 | |

We can manufacture filters for higher cylindrical height (please check with us)

DPPC SERIES Ø 2040-3000

DPPC SERIES

Manufactured and calculated according to EN 13121-3.
 Material: Hand lay-up polyester with fiberglass (max quality polyester tech).
 Steel reinforced GRP vessel.
 Flanged connections for INLET/OUTLET or PVC lids.
 All connections are part of the structure of the filter in GRP.
 Closed legs & part of the filter structure.
 Side manhole.
 Design temperature 40°C.
 Bottom nozzle plate. (GRP + Steel)
 Top nozzle plate. (GRP + Steel)
 Leg extension for bottom connection (up to 500 mm) or complete drain.
 Tested 1.5 times design pressure
 Resin transfer flanges DN80 included

ADDITIONAL OPTIONS

Higher temperatures. (Ask us)
 High-chemical resistance. (Ask us) [See page 31](#)
 Cylindrical height ad-hoc. ([Check below](#))
 Additional sight glass. [See page 31](#)
 Additional flanges. [See page 31](#)
 Anchorage system to ground. [See page 31](#)
 Seismic calculations. (Ask us)
 Drinking water / Food contact. (Ask us)
 Lateral manhole Ø500 mm.

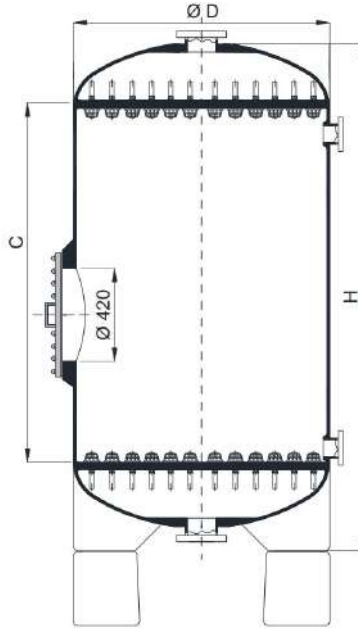

Optional Flanged Load/Unload

Plastized Manhole lid

2 x Steel ARMORED Nozzle plate

Optional sightglass

Leg extension in GRP

Optional Lid connections

Standard flanged connections

Customizable height

| Design Pressure | | DPPC-2040 C=1650 *H=2720 | DPPC-2210 C=1655 *H=2840 | DPPC-2340 C=1660 *H=2850 | DPPC-2550 C=1680 *H=2920 | DPPC-2800 C=1680 *H=3040 | DPPC-3000 C=1710 *H=3070 |
|--------------------------|------------|--|--|--|--|--|--|
| 2.5 Kg/cm ² | Ref. | 382220 | 382222 | 382223 | 382225 | 382228 | 382230 |
| | Price | 41 012 € | 45 483 € | 48 643 € | 56 723 € | 66 136 € | 75 618 € |
| | Δ 100 mm | 384 € | 395 € | 420 € | 495 € | 636 € | 858 € |
| 4 Kg/cm ² | Ref. | 384220 | 384222 | 384223 | 384225 | 384228 | 384230 |
| | Price | 46 159 € | 51 346 € | 54 233 € | 64 268 € | 78 005 € | 85 804 € |
| | Δ 100 mm | 430 € | 450 € | 490 € | 560 € | 683 € | 903 € |
| 5 Kg/cm ² | Ref. | 385220 | 385222 | 385223 | 385225 | 385228 | 385230 |
| | Price | 48 695 € | 55 810 € | 59 296 € | 69 716 € | 82 601 € | 95 315 € |
| | Δ 100 mm | 504 € | 543 € | 580 € | 655 € | 783 € | 922 € |
| 6 Kg/cm ² | Ref. | 386220 | 386222 | 386223 | 386225 | 386228 | 386230 |
| | Price | 51 681 € | 60 467 € | 63 969 € | 74 145 € | 89 644 € | 102 580 € |
| | Δ 100 mm | 620 € | 650 € | 690 € | 750 € | 816 € | 945 € |
| Recomended! | Sightglass | +540 € | +540 € | +540 € | +540 € | +540 € | +540 € |
| Minimum C for manhole | | 1650 | 1655 | 1660 | 1680 | 1680 | 1710 |
| Maximum C for 1 cylinder | | 2480 | 2405 | 2410 | 2510 | 2510 | 2410 |

We can manufacture filters for higher cylindrical height (please check with us)

DPPP/KPPP SERIES Ø 415-3000 (THREE NOZZLE PLATE)

DPPP/KPPP SERIES

Manufactured and calculated according to EN 13121-3.
 Material: Hand lay-up polyester with fiberglass (max quality polyester tech).
 Steel reinforced GRP vessel.
 Flanged connections for INLET/OUTLET or PVC lid in the bottom.
 All connections are part of the structure of the filter in GRP.
 Closed legs & part of the filter structure.
 2 x Side manhole.
 Design temperature 40°C.
 Top mid & bottom nozzle plate. (GRP + Steel)
 Longer legs for bottom connection or complete drain.
 Tested 1.5 times design pressure

ADDITIONAL OPTIONS

Higher temperatures. (Ask us)
 High-chemical resistance. (Ask us) [See page 31](#)
 Cylindrical height ad-hoc.
 Additional sight glass. [See page 31](#)
 Additional flanges. [See page 31](#)
 Anchorage system to ground. [See page 31](#)
 Seismic calculations. (Ask us)
 Drinking water / Food contact. (Ask us)
 Lateral manhole Ø500 mm. [See page 31](#)

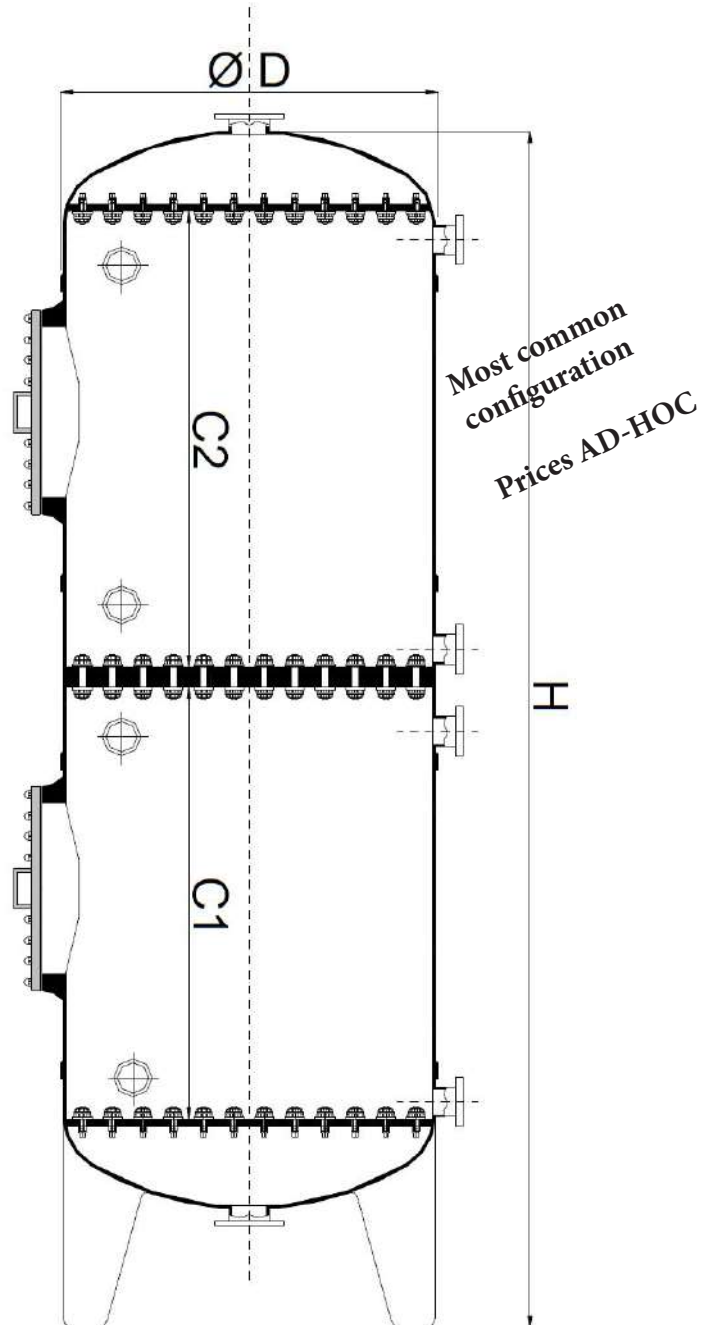

4 x Flanged Load/Unload



2 x Plastized Manhole lid



3 x Steel ARMORED Nozzle plate



Mid plate double thickness



4 x Sightglass



Optional Lid connections



Long legs detail

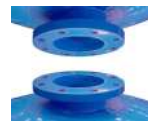

Optional flanged connections



Customizable height

MB SERIES Ø 415-3000 (MIXED BEDS)

MIXED BEDS

Manufactured and calculated according to EN 13121-3.
 Material: Hand lay-up polyester with fiberglass (max quality polyester tech).
 Steel reinforced GRP vessel.
 Flanged connections for INLET/OUTLET or PVC lid in the bottom.
 All connections are part of the structure of the filter in GRP.
 Closed legs & part of the filter structure.
 Side manhole & elliptical top manhole.
 Design temperature 40°C.
 Bottom nozzle plate. (GRP + Steel)
 Longer legs for bottom connection or complete drain.
 Mid distributor included.
 Tested 1.5 times design pressure

ADDITIONAL OPTIONS

Higher temperatures. (Ask us)
 High-chemical resistance. (Ask us) [See page 31](#)
 Cylindrical height ad-hoc.
 Additional sight glass. [See page 31](#)
 Additional flanges. [See page 31](#)
 Anchorage system to ground. [See page 31](#)
 Seismic calculations. (Ask us)
 Drinking water / Food contact (Ask us)
 Lateral manhole Ø500 mm. [See page 31](#)
 Mid distributor provided by engineering company (Ask us).

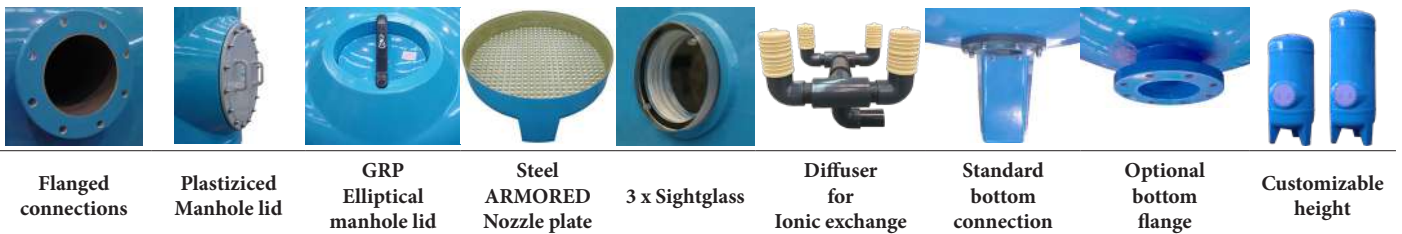
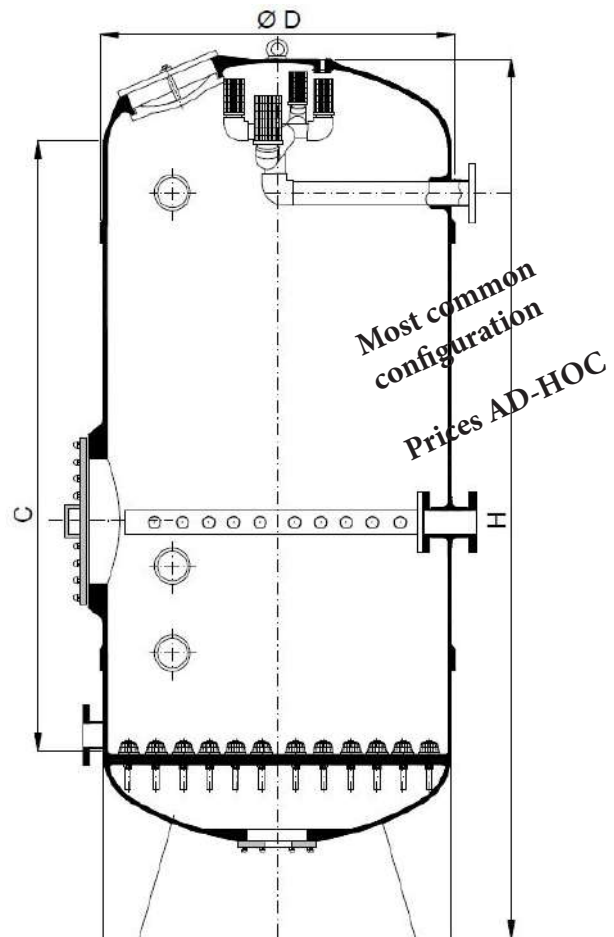

Types of mid distributors



STANDARD PUMP STRAINERS

STANDARD PUMP STRAINERS POSITION 2

| Ref | ID | Connections | Basket | Max press. | Price |
|----------|---------|-------------|-----------|------------|---------|
| 410811.S | P8/110 | DN100 | 8 litres | 1 bar | 1 900 € |
| 411511.S | P15/110 | DN100 | 15 litres | 1 bar | 2 195 € |
| 412516.S | P25/160 | DN150 | 25 litres | 1 bar | 2 475 € |
| 412522.S | P25/225 | DN200 | 25 litres | 1 bar | 2 545 € |
| 416030.S | P60/300 | DN300 | 60 litres | 1 bar | 3 435 € |

CHARACTERISTICS

1 bar Max. pressure.
Quick opening device.
304 Stainless steel Ø4 mm hole.
Extremely robust.
Designed for suction side.

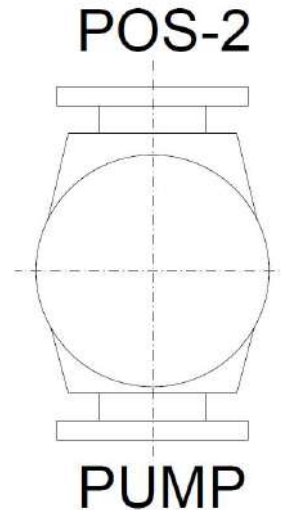
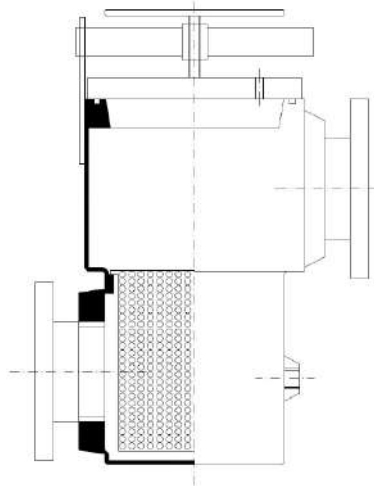

STANDARD PUMP STRAINERS COLLECTORS

| Ref | ID | Aspiration | Pump | Basket | Max press. | Price |
|-----------|---------------|------------|---------|-----------|------------|---------|
| 412516.22 | P25/2x160-225 | 2xDN150 | DN200 | 25 litres | 1 bar | 2 870 € |
| 412522.16 | P25/225-2x160 | DN200 | 2xDN150 | 25 litres | 1 bar | 2 870 € |
| 416022.30 | P60/2x225-300 | 2 x DN200 | DN300 | 60 litres | 1 bar | 3 825 € |
| 416030.22 | P60/300-2x225 | DN300 | 2xDN200 | 60 litres | 1 bar | 3 825 € |

CHARACTERISTICS

1 bar Max. pressure.
Quick opening device.
304 Stainless steel Ø4 mm hole.
Extremely robust.
Designed for suction side.

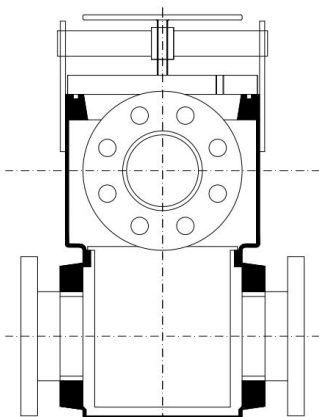

1 INLET - 2 OUTLET



Example: 1 aspiration / 2 pump

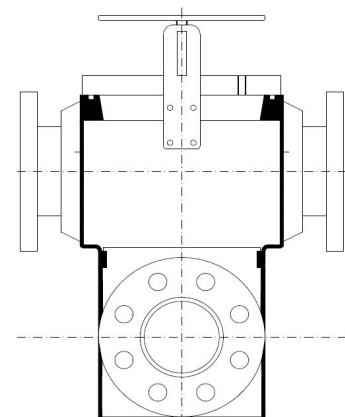

2 INLET - 1 OUTLET

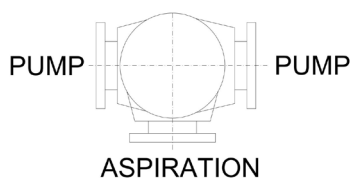

PUMP PUMP
ASPIRATION

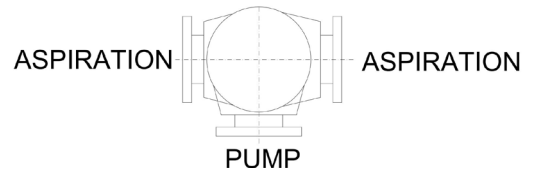

ASPIRATION ASPIRATION
PUMP

CUSTOMIZED PUMP STRAINERS

| Basket capacity: 4 l ~ Flow 30 m³/h | | | | Basket capacity: 8 l ~ Flow 80 m³/h | | | | Basket capacity: 15 l ~ Flow 120 m³/h | | | |
|---------------------------------------|-------|-------------|---------|---------------------------------------|--------|-------------|---------|---|---------|-------------|---------|
| Ref | ID | Connections | Price | Ref | ID | Connections | Price | Ref | ID | Connections | Price |
| 410403 | P4/32 | DN25 | 1 575 € | 410805 | P8/50 | DN40 | 2 315 € | 411507 | P15/75 | DN65 | 2 690 € |
| 410404 | P4/40 | DN32 | 1 585 € | 410806 | P8/63 | DN50 | 2 325 € | 411509 | P15/90 | DN80 | 2 715 € |
| 410405 | P4/50 | DN40 | 1 590 € | 410807 | P8/75 | DN65 | 2 335 € | 411511 | P15/110 | DN100 | 2 735 € |
| 410406 | P4/63 | DN50 | 1 600 € | 410809 | P8/90 | DN80 | 2 355 € | 411512 | P15/125 | DN110 | 2 755 € |
| 410407 | P4/75 | DN65 | 1 620 € | 410811 | P8/110 | DN100 | 2 375 € | 411514 | P15/140 | DN125 | 2 785 € |
| 410409 | P4/90 | DN80 | 1 635 € | 410812 | P8/125 | DN110 | 2 395 € | 411516 | P15/160 | DN150 | 2 825 € |
| | | | | 410814 | P8/140 | DN125 | 2 425 € | 411520 | P15/200 | DN175 | 2 870 € |
| | | | | 410816 | P8/160 | DN150 | 2 470 € | 411522 | P15/225 | DN200 | 2 905 € |
| P4 Basket SS 316: +35 € | | | | P8 Basket SS 316: +55 € | | | | P15 Basket SS 316: +75 € | | | |

| Basket capacity: 25 l ~ Flow 250 m³/h | | | | Basket capacity: 60 l ~ Flow 350 m³/h | | | | Basket capacity: 75 l ~ Flow 600 m³/h | | | |
|---|---------|-------------|---------|---|---------|-------------|---------|---|---------|-------------|---------|
| Ref | ID | Connections | Price | Ref | ID | Connections | Price | Ref | ID | Connections | Price |
| 412509 | P25/90 | DN80 | 2 980 € | 416012 | P60/125 | DN110 | 4 005 € | 417525 | P75/250 | DN250 | 4 575 € |
| 412511 | P25/110 | DN100 | 3 005 € | 416014 | P60/140 | DN125 | 4 040 € | 417530 | P75/300 | DN300 | 4 645 € |
| 412512 | P25/125 | DN110 | 3 025 € | 416016 | P60/160 | DN150 | 4 080 € | 417535 | P75/350 | DN350 | 4 720 € |
| 412514 | P25/140 | DN125 | 3 055 € | 416020 | P60/200 | DN175 | 4 125 € | 417540 | P75/400 | DN400 | 4 895 € |
| 412516 | P25/160 | DN150 | 3 095 € | 416022 | P60/225 | DN200 | 4 160 € | 417545 | P75/450 | DN450 | 5 010 € |
| 412520 | P25/200 | DN175 | 3 140 € | 416025 | P60/250 | DN250 | 4 215 € | 417550 | P75/500 | DN500 | 5 300 € |
| 412522 | P25/225 | DN200 | 3 175 € | 416030 | P60/300 | DN300 | 4 290 € | | | | |
| 412525 | P25/250 | DN250 | 3 235 € | 416035 | P60/350 | DN350 | 4 365 € | | | | |
| P25 Basket SS 316: +85 € | | | | P60 Basket SS 316: +160 € | | | | P75 Basket SS 316: +175 € | | | |

PUMP STRAINERS

Flanged connections for INLET/OUTLET
 All connections are part of the structure of the filter in GRP.
 1 bar Max. pressure.
 Quick opening device.
 304 Stainless steel Ø4 mm hole.
 Extremely robust.
 Designed for suction side.
 Basket hole Ø4 mm.
 Flange position customizable in angle.
 Design temperature 40°C.

ADDITIONAL OPTIONS

Different Inlet/Outlet flange sizes in same strainer.
 Stainless steel 316 available at order. [See yellow boxes](#)
 Optional basket hole size Ø2mm.

USE IT AS A COLLECTOR!

Multiple flanges for inlet or outlet.
 Just add price of flange. [See page 20](#)



P25 5 Kg/cm²

+20% price increase according to model

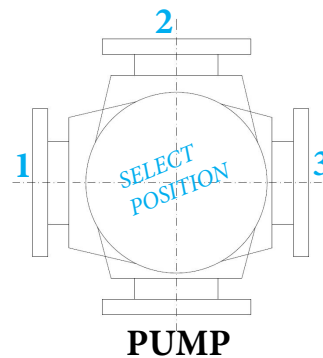
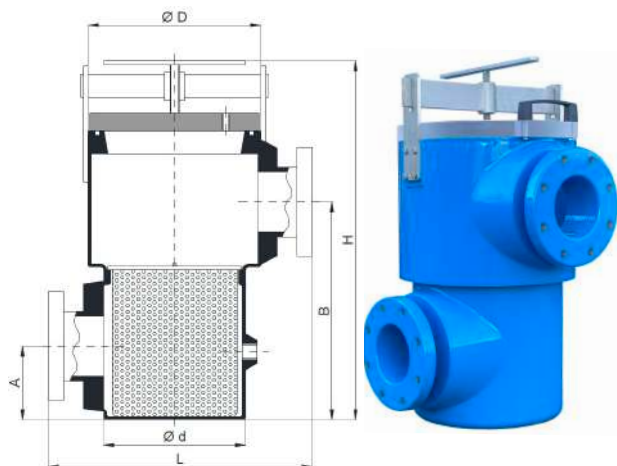

PUMP

| MODEL | D | d | H | L | A | B |
|-------|-----|-----|------|-----|-----|-----|
| P4 | 250 | 200 | 500 | 370 | 100 | 290 |
| P8 | 305 | 250 | 635 | 450 | 130 | 370 |
| P15 | 355 | 300 | 760 | 500 | 150 | 455 |
| P25 | 415 | 315 | 785 | 560 | 165 | 495 |
| P60 | 530 | 480 | 1030 | 700 | 260 | 695 |
| P75 | 530 | 480 | 1260 | 700 | 300 | 850 |

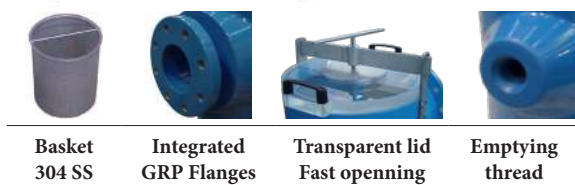

Basket 304 SS Integrated GRP Flanges Transparent lid Fast opening Emptying thread

DEGASSIFIERS Ø 415 - 2550

DEGASSIFIERS

Atmospheric vessel.
 Material: Hand lay-up polyester with fiberglass (max quality polyester tech).
 Steel reinforced GRP vessel.
 Flanged connections for INLET/OUTLET or PVC lid in the bottom.
 All connections are part of the structure of the filter in GRP.
 Closed legs & part of the filter structure.
 Side manhole.
 Design temperature 40°C.
 Drilled plate or PVC grid (According to diameter)

ADDITIONAL OPTIONS

Higher temperatures. (Ask us)
 High-chemical resistance. (Ask us) [See page 31](#)
 Cylindrical height ad-hoc. (Check below)
 Additional sight glass. [See page 31](#)
 Additional flanges. [See page 31](#)
 Anchorage system to ground. [See page 31](#)
 Seismic calculations. (Ask us)
 Additional tank available. [See page 28](#) ----->



G-415 - G-960

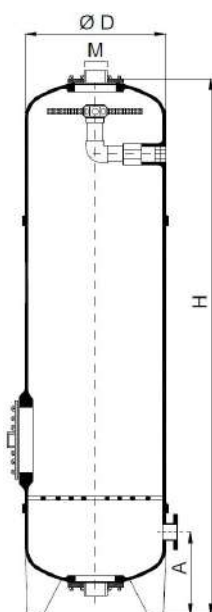

G-1010 - G-2550

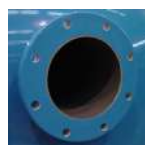
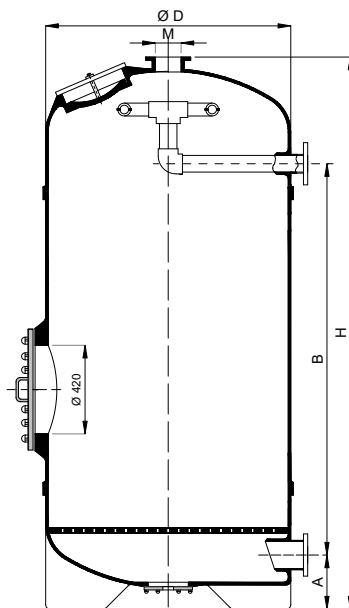

Flanged connections



Plastized Manhole lid



GRP Elliptical manhole lid



Support for rings G415-G960



Support for rings G1010-G2550



Threaded connections



Optional sightglass



Customizable height

| ID | G-415 | G-460 | G-520 | G-640 | G-720 | G-840 | G-960 |
|-------|---------|---------|---------|---------|---------|---------|---------|
| Ref. | 522041 | 522046 | 522052 | 522064 | 522072 | 522084 | 522096 |
| Ø | 415 | 460 | 520 | 640 | 720 | 840 | 960 |
| H | 2355 | 2370 | 2385 | 2435 | 2460 | 2580 | 2700 |
| Price | 3 975 € | 4 522 € | 4 868 € | 5 495 € | 6 095 € | 6 785 € | 8 010 € |

| ID | G-1010 | G-1160 | G-1260 | G-1440 | G-1640 | G-1840 | G-2040 | G-2210 | G-2340 | G-2550 |
|-------|---------|----------|----------|----------|----------|----------|----------|----------|----------|----------|
| Ref. | 522010 | 522011 | 522012 | 522014 | 522016 | 522018 | 522020 | 522022 | 522023 | 522025 |
| Ø | 1010 | 1160 | 1260 | 1440 | 1640 | 1840 | 2040 | 2210 | 2340 | 2550 |
| H | 2800 | 2900 | 2950 | 3070 | 3270 | 3270 | 3470 | 3500 | 3570 | 3740 |
| Price | 9 669 € | 11 498 € | 13 275 € | 16 862 € | 20 475 € | 24 933 € | 32 925 € | 36 395 € | 39 050 € | 45 660 € |

DECANTERS Ø 1260 - 2550

DECANTERS

Material: Hand lay-up polyester with fiberglass (max quality polyester tech).
 Flanged connections for INLET/OUTLET.
 All connections are part of the structure of the filter in GRP.
 Closed legs & part of the filter structure.
 Design temperature 40°C.

ADDITIONAL OPTIONS

Higher temperatures. (Ask us)
 High-chemical resistance. (Ask us)
 Cylindrical height ad-hoc.
 Additional sight glass. [See page 31](#)
 Additional flanges. [See page 31](#)
 Anchorage system to ground. [See page 31](#)
 Seismic calculations. (Ask us)
 Folding lids can be also included.

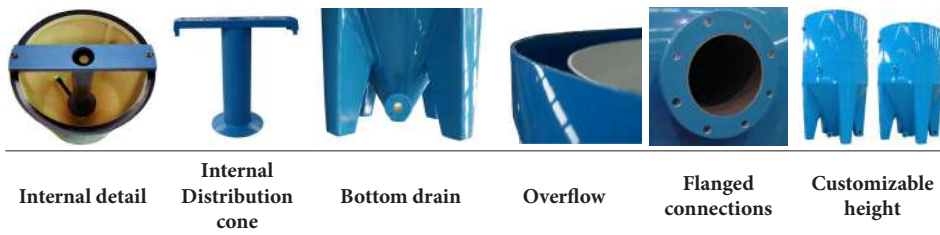
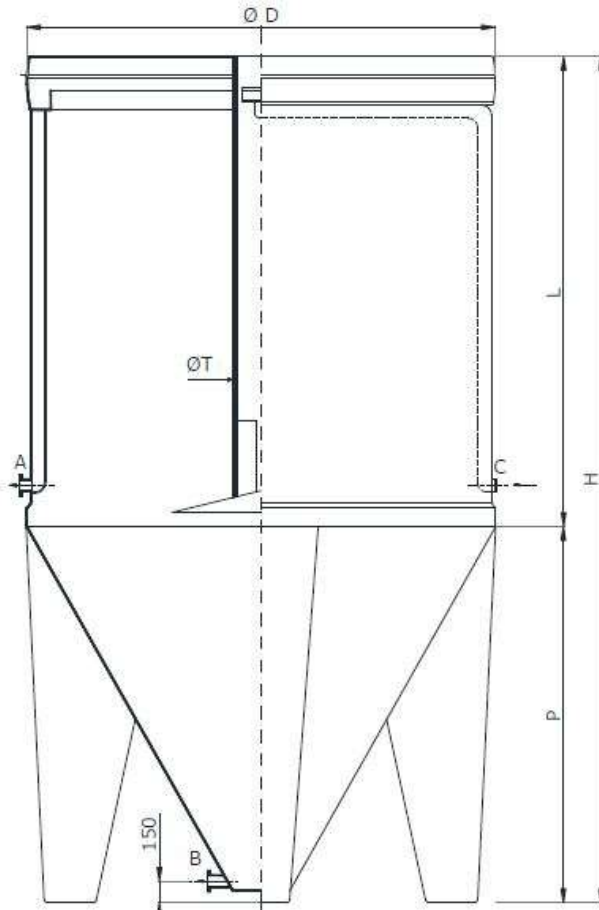

| | DEC-1260 | DEC-1640 | DEC-2040 | DEC-2340 | DEC-2550 |
|----------|----------|----------|----------|----------|----------|
| Ref. | 522412 | 522416 | 522420 | 522423 | 522425 |
| Ø | 1260 | 1640 | 2040 | 2340 | 2550 |
| P | 1100 | 1280 | 1650 | 1900 | 2200 |
| L | 1200 | 1650 | 1650 | 1650 | 1650 |
| H | 2300 | 2930 | 3300 | 3550 | 3850 |
| Price | 7 957 € | 9 805 € | 14 031 € | 15 891 € | 18 156 € |
| Δ 800 mm | 1 105 € | 1 256 € | 1 941 € | 2 950 € | 5 118 € |

TANKS & MIXING TANKS Ø 520 - 2550

ATMOSPHERIC TANKS

Atmospheric vessel.
 Material: Hand lay-up polyester with fiberglass (max quality polyester tech).
 Steel reinforced GRP vessel.
 All connections are part of the structure of the filter in GRP.
 Design temperature 40°C.
 R model Flat bottom
 RP Closed legs.

ADDITIONAL OPTIONS

Higher temperatures. (Ask us)
 High-chemical resistance. (Ask us) [See below](#)
 Additional sight glass. [See page 31](#)
 Additional flanges. [See page 31](#)
 Anchorage system to ground. [See page 31](#)
 Seismic calculations. (Ask us)

R TANKS

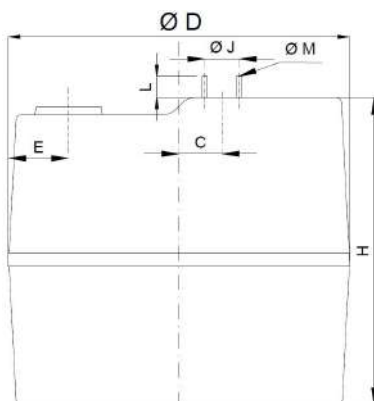

RP TANKS

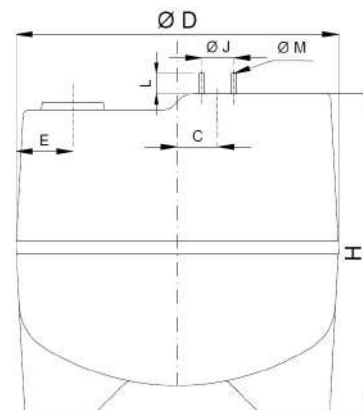

Optional Flanged connections



Optional Threaded connections



Elliptical Top Manhole

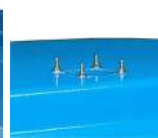

Optional Stirrer Support



Optional Water Level

| Ø | 520 | 640 | 720 | 840 | 1010 | 1260 | 1440 | 1640 | 2040 | 2040 | 2040 | 2340 | 2550 |
|--------|---------|---------|---------|---------|---------|---------|---------|---------|---------|---------|---------|---------|----------|
| ID | R - 02 | R - 03 | R - 04 | R - 06 | R - 10 | R - 13 | R - 17 | R - 25 | R - 35 | R - 45 | R - 50 | R - 75 | R - 100 |
| Ref. | 522152 | 522164 | 522172 | 522184 | 522110 | 522112 | 522114 | 522116 | 522120 | 522120 | 522120 | 522123 | 522125 |
| H | 1050 | 1050 | 1050 | 1330 | 1330 | 1330 | 1330 | 1330 | 1330 | 1605 | 1880 | 1880 | 2110 |
| Volume | 200 | 300 | 400 | 660 | 975 | 1500 | 2000 | 2575 | 4000 | 4880 | 5750 | 7600 | 10000 |
| Price | 877 € | 1 392 € | 1 845 € | 2 534 € | 3 037 € | 3 667 € | 4 511 € | 5 206 € | 6 572 € | 7 070 € | 7 712 € | 8 884 € | 11 452 € |
| ID | RP - 02 | RP - 03 | RP - 04 | RP - 06 | RP - 10 | RP - 13 | RP - 17 | RP - 25 | RP - 35 | | RP - 50 | RP - 75 | RP - 100 |
| Ref. | 522252 | 522264 | 522272 | 522284 | 522210 | 522212 | 522214 | 522216 | 522220 | | 522220 | 522223 | 522225 |
| H | 1015 | 1035 | 1065 | 1075 | 1360 | 1460 | 1500 | 1610 | 1670 | | 1970 | 2035 | 2110 |
| Volume | 140 | 240 | 340 | 520 | 840 | 1350 | 1870 | 2550 | 4000 | | 5000 | 7000 | 9000 |
| Price | 995 € | 1 525 € | 2 034 € | 2 787 € | 3 401 € | 4 123 € | 5 017 € | 5 783 € | 7 801 € | | 8 442 € | 9 705 € | 12 433 € |

Price

| | |
|---|------------|
| GRP Deflector (3 inside) | 350 € |
| Mixing funnel | 280 € |
| Stirrer support / Tank in the top | 335 € |
| Water level indicator | 280 € |
| High Chemical resistance for tanks (Always check with us) | 50 € + 12% |

NEED MORE VOLUME? CHECK WITH US!



MEDIATRAPS

MEDIATRAPS

Material: Hand lay-up polyester with fiberglass (max quality polyester tech) or PVC
 GRP Media traps manufactured and calculated according to EN 13121-3.
 Steel reinforced GRP vessel.
 Flanged connections for INLET/OUTLET or PVC.
 Design temperature 40°C.
 KSH internal nozzles 0.2 mm.

ADDITIONAL OPTIONS

Higher temperatures. (Ask us)
 High-chemical resistance. (Ask us) [See page 31](#)
 Additional sight glass. [See page 31](#)
 Additional flanges. [See page 31](#)
 Drinking water / Food contact. (Ask us)



| ID | S - 20 | S - 40 | S - 120 | S - 200 | S - 280 | S - 600 |
|-----------------|--------------|--------------|----------------|----------------|----------------|---------------|
| Ref. | 426000 | 426001 | 426003 | 426005 | 4260007 | 4260015 |
| Max. Flow | 20 m3/h | 40 m3/h | 120 m3/h | 200 m3/h | 280 m3/h | 600 m3/h |
| Max Connections | Ø 63 (DN 50) | Ø 90 (DN 80) | Ø 140 (DN 125) | Ø 225 (DN 200) | Ø 280 (DN 250) | Ø 505(DN 350) |
| Diameter | Ø110 | Ø230 | Ø360 | Ø415 | Ø460 | Ø730 |
| Length | 465 | 560 | 750 | 770 | 770 | 930 |
| Pressure | 6 kg/cm2 | 6 kg/cm2 | 6 kg/cm2 | 6 kg/cm2 | 6 kg/cm2 | 6 kg/cm2 |
| Material | PVC | PVC | GRP | GRP | GRP | GRP |
| Price | 469 € | 1 080 € | 1 836 € | 2 777 € | 3 627 € | 8 161 € |

FILTRATION / PILOT PLANT SKIDS

CALPLAS / DRYDEN AQUA FILTRATION UNITS



| ID | Description | Price |
|---------|---|----------|
| 64564 | Calplas Filter AFM-640 mm , 0.3m ² Speck Badu Delta ECO VS 1.10 kW 230 V 3x Besgo DN50/d63 & air compressor, pressure switch Filtration control panel - ASC3, APF [®] dosing pump. Dimensions: 1500 x 780 x 1800 mm (l * w * h) AFM bags: 14 (25 Kg) Not included | 12 650 € |
| 64572 | Calplas Filter AFM-720 mm , 0.4m ² Speck Badu Delta ECO VS 1.10 kW 230 V 3x Besgo DN50/d63 & air compressor, pressure switch Filtration control panel - ASC3, APF [®] dosing pump. Dimensions: 1500 x 780 x 1800 mm (l * w * h) AFM bags: 19 (25 Kg) Not included | 12 990 € |
| 64572.S | SEA WATER EDITION Calplas Filter AFM-720 mm , 0.4m ² Speck Badu Delta ECO VS 1.10 kW 230 V (Sea water) 3x Besgo DN50/d63 (Sea water) & air compressor, pressure switch Filtration control panel - ASC3, APF [®] dosing pump. Dimensions: 1500 x 780 x 1800 mm (l * w * h) AFM bags: 19 (25 Kg) Not included | 14 290 € |
| 64596 | Calplas Filter AFM-960 mm , 0.7m ² Speck Badu ECO Motion 3x Besgo DN65/d75 & air compressor, pressure switch Filtration control panel - ASC3, APF [®] dosing pump. Dimensions: 1850 x 1120 x 1800 mm (l * w * h) AFM bags: 37 (25 Kg) Not included | 17 990 € |

Price of systems excluding AFM[®] & APF[®]



FILTRATION WITH CALPLAS 640/720/960

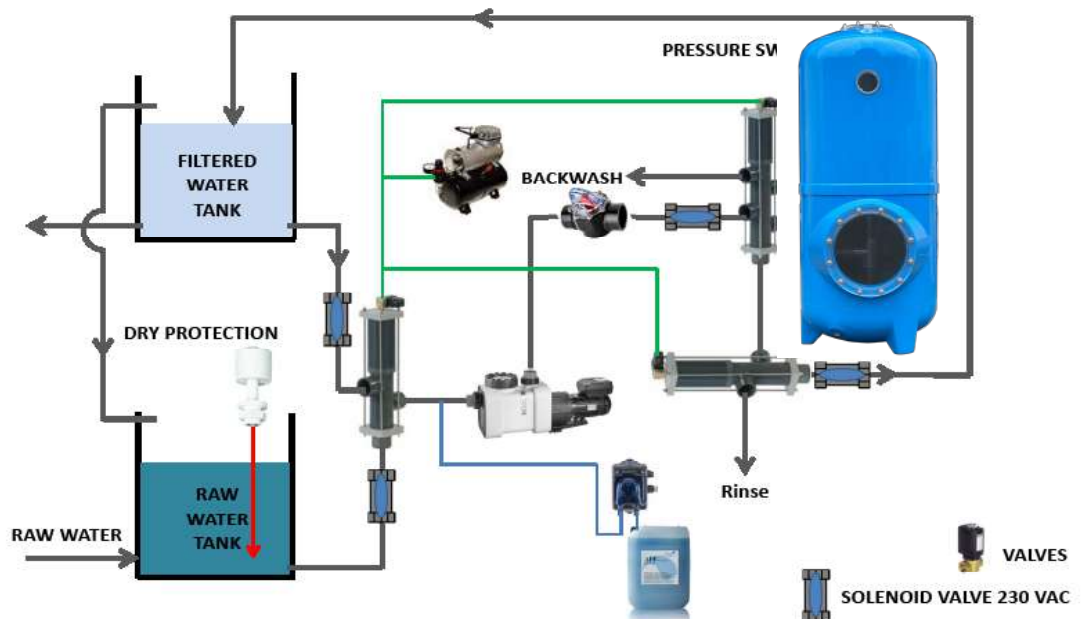

ADDITIONAL ELEMENTS

SIGHT GLASS



| ID | Price |
|---|-------|
| Circular sight glass 2 1/2" - From Ø415 to Ø520 | 255 € |
| Circular sight glass 3" - From Ø640 to Ø840 | 320 € |
| Circular sight glass 4" - From Ø960 to Ø1440 | 375 € |
| Circular sight glass 5" - From Ø1640 to Ø1840 | 455 € |
| Circular sight glass 6" - From Ø2040 to Ø3000 | 540 € |

**CHEMICAL LINING INCREASES
SEE BELOW**

Standard Lining for
Food Contact / Drinking water

50 € + 8%

LONG SIGHT GLASS (only available for 2.5 bar design pressure)



| ID | Price |
|--------------------------------------|-------|
| Standard vertical sight glass 200 mm | 720 € |
| Long vertical sight glass 300 mm | 825 € |

Anionic Column Regeneration
(NaOH[5%])
Tmax in regeneration=30°C
Higher values check with us

50 € + 8%

Cationic Column Regeneration
(HCl or H₂SO₄)[5%]
Tmax in regeneration=30°C
Higher values check with us

50 € + 5%

Cationic Column Regeneration
(NaCl)

0 %

THREADED I/O



| ID | Price |
|-----------------------------------|-------|
| Threaded I/O - from 1/2" up to 1" | 66 € |
| Threaded I/O - from 1 1/4" to 2" | 89 € |
| Threaded I/O - from 2 1/2" to 4" | 113 € |

Anionic or Cationic Column Regeneration
+ Standard Lining
Food Contact / Drinking water
NaOH HCl H₂SO₄ [5%]
Tmax in regeneration=30°C
Higher values check with us

50 € + 10%

FLANGES

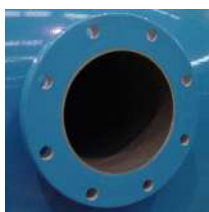

| ID | Price |
|--|---------|
| Polyester flange - from DN15 up to DN 25 | 135 € |
| Polyester flange - from DN32 up to DN 65 | 250 € |
| Polyester flange - from DN 80 up to DN 100 | 315 € |
| Polyester flange - from DN 125 | 355 € |
| Polyester flange - from DN 150 | 455 € |
| Polyester flange - from DN 200 | 560 € |
| Polyester flange - from DN 250 | 620 € |
| Polyester flange - from DN 300 | 665 € |
| Polyester flange - from DN 350 | 770 € |
| Polyester flange - from DN 400 | 880 € |
| Polyester flange - from DN 450 | 975 € |
| Polyester flange - from DN 500 | 1 085 € |

ACS certification

Check with us.

Ozone max 1 ppm

50 € + 8%

Special conditions

Check with us

HANDHOLE



Hand hole
Ø160/Ø200 mm

625 €

UPGRADE MANHOLE Ø420 to Ø500

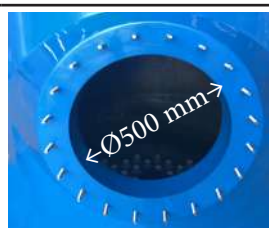

Only for Ø1010 -Ø3000
Only Metallic lid

800 €

PIPE SUPPORT



Per unit

215 €

STANDARD FIXING HOLES

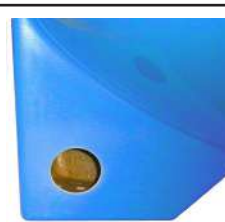

Holes for 3 legs + Access

220 €

NAME PLATE SUPPORT



GRP plate

195 €

WHAT IS AFM?

AFM® is quite simply the most efficient granular filtration medium available on the market. It is highly engineered to give optimum mechanical filtration performance in a range of industrial and municipal water filtration applications. Activated to increase the surface area up to 300 times that of crushed glass or sand and chemically and thermally treated to ensure permanent negatively charged surface properties that make AFM® self-sterilising.

AFM® replaces sand in all filtration applications and can be used in a conventional sand filter without modification.

WHY AFM?

Will not support bacterial growth

At up to 20m/h will consistently filter, without flocculation:

-- >95% of 1 µ particles (Grade 1).

-- >95% of 1µ particles (Grade 0).

Will selectively filter positively charged ionic particles such as heavy metals.

Will not suffer from channelling or preferential pathways.

Will consistently evacuate more than 95% of retained particles with 50% or less water than required for sand. (backwash duration 5 mins max at 45m/h).

Service lifespan of 10 - 15 years or more.

CALPLAS FILTERS + AFM INSTALLATIONS



SELF-STERILIZING SURFACE RESISTANT TO BACTERIAL GROWTH



Water molecules and dissolved oxygen

Transformed into free radicals on the surface of AFM® (catalytic reaction)



Inhibits biofouling and protects AFM® from bacterial colonisation. Free radicals oxidise dissolved organic matter and heavy metals.

INCREASED SURFACE AREA FOR SUPERIOR FILTRATION



Large surface area provides for superior mechanical filtration

Optimal sphericity, uniformity coefficient, particle size and shape of grain for best hydraulic performance (not round, not flat, no broken bits of glass)

Surface Area by Langmuir Isotherm Method 1'000kg: AFM = 50.000 m² / Sand 3.000 m²

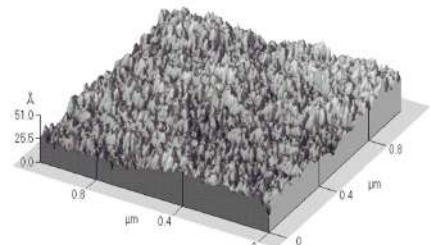

AFM[®] NG HYDROPHOBIC, NEUTRAL SURFACE CHARGE

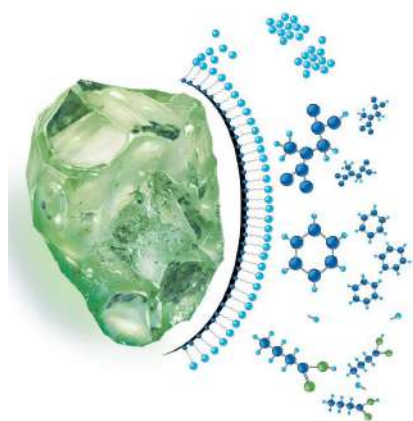

Superior mechanical filtration up to 1µm particles (95% removal)

Adsorption of organic substances including Hydrocarbon and Microplastic

AFM[®]S (STANDARD) NEGATIVE SURFACE CHARGE

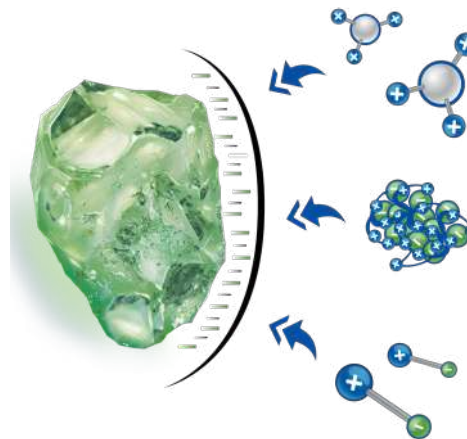

Superior mechanical filtration up to 4µm particles (98% removal)

Adsorption of positively charged particles, flocs and metals (Fe, Mn, As)

RECOMMENDED OPERATIONAL PARAMETERS

| PARAMETER | Value |
|--------------------------------------|---|
| Filtration velocity | 1 - 30 m ³ /h/m ² |
| Back Wash Velocity | 30 - 50 m/h (20 m/h Ask) |
| Max. operating differential pressure | < 0.5 bar |
| Back Wash Duration | for 3 - 5/10 mins |
| Water pH limits | 4 - 10 |
| Water temperature limits | 1 - 100°C |

AFM CERTIFICATIONS:

- ISO 9001, 14001 & 18001.
- NSF 50 & 61 for potable water use.
- DWI EC Regulation 31 certification for potable water use.
- European Water Directive (98/83/EC) & 80/778/EEC) compliant.
- BSEN12902 and BSEN12904 compliant.
- Independently tested by accredited laboratory, IFTS



| Ref | ID | Package quantity | Price |
|------|---|------------------|--------|
| 6400 | AFM [®] Grade 0 St (0.25-0.5 mm) | (25 Kg/bag) | 44 € |
| 6401 | AFM [®] Grade 1 St (0.4-0.8 mm) | (25 Kg/bag) | 44 € |
| 6431 | AFM [®] Grade 1 NG (0.4-0.8 mm) | (25 Kg/bag) | 44 € |
| 6432 | AFM [®] Grade 2 NG (0.7-2.0 mm) | (25 Kg/bag) | 44 € |
| 6403 | AFM [®] Grade 3 St (2.0-4.0 mm) | (25 Kg/bag) | 44 € |
| 6410 | AFM [®] Grade 0 St (0.25-0.5 mm) | 1 Tn/bag | 1680 € |
| 6411 | AFM [®] Grade 1 St (0.4-0.8 mm) | 1 Tn/bag | 1680 € |
| 6441 | AFM [®] Grade 1 NG (0.4-0.8 mm) | 1 Tn/bag | 1680 € |
| 6442 | AFM [®] Grade 2 NG (0.7-2.0 mm) | 1 Tn/bag | 1680 € |
| 6413 | AFM [®] Grade 3 St (2.0-4.0 mm) | 1 Tn/bag | 1680 € |

ANTHRACITE & ACTIVATED CARBON



| Ref | ID | Package quantity | Price |
|------|--|------------------|-------|
| 6100 | Anthracite N-(0.8 - 1.6 mm) 720 Kg/m ³ | (50 l/bag) | 80 € |
| 6101 | Anthracite N-(1.4 - 2.5 mm) 720 Kg/m ³ | (50 l/bag) | 80 € |



| Ref | ID | Package quantity | Price |
|------|---|------------------|-------|
| 6200 | Activated Carbon from Coconut Shells (1.18-2.36 mm) 500 Kg/m ³ | (50 l/bag) | 200 € |

BESGO VALVES

BESGO



5 WAY VALVES (Standard OK for 0.5 % Salinity)

| Ref | ID | Price |
|---------|---|---------|
| 60040 | Besgo DN40 / d50 mm / 1½" Distance 190 mm | 750 € |
| 60050 | Besgo DN50 / d63 mm / 2" Distance 190 mm | 830 € |
| 60065 | Besgo DN65 / d75 mm / 2½" Distance 250 mm | 1 090 € |
| 60080 | Besgo DN80 / d90 mm / 3" Distance 300 mm | 1 690 € |
| 60100 | Besgo DN100 / d110 mm / 4" Distance 400 mm | 2 490 € |
| 60125 | Besgo DN125 / d140 mm / 5" Distance 450 mm | 4 390 € |
| 60050.S | Besgo DN50 / d63 mm / 2" Distance 190 mm Sea water | 950 € |
| 60065.S | Besgo DN65 / d75 mm / 2½" Distance 250 mm Sea water | 1 290 € |
| 60080.S | Besgo DN80 / d90 mm / 3" Distance 300 mm Sea water | 1 990 € |
| 60100.S | Besgo DN100 / d110 mm / 4" Distance 400 mm Sea water | 3 090 € |
| 60125.S | Besgo DN125 / d140 mm / 5" Distance 450 mm Sea water | 5 200 € |

3 WAY VALVES (Standard OK for 0.5 % Salinity)

| Ref | ID | Price |
|---------|---|---------|
| 60045 | Besgo DN40 / d50 mm / 1½" | 630 € |
| 60055 | Besgo DN50 / d63 mm / 2" | 690 € |
| 60068 | Besgo DN65 / d75 mm / 2½" | 920 € |
| 60082 | Besgo DN80 / d90 mm / 3" | 1 390 € |
| 60101 | Besgo DN100 / d110 mm / 4" | 2 090 € |
| 60126 | Besgo DN125 / d140 mm / 5" | 3 790 € |
| 60055.S | Besgo DN50 / d63 mm / 2" Sea water | 850 € |
| 60068.S | Besgo DN65 / d75 mm / 2½" Sea water | 1 050 € |
| 60082.S | Besgo DN80 / d90 mm / 3" Sea water | 1 650 € |
| 60101.S | Besgo DN100 / d110 mm / 4" Sea water | 2 490 € |
| 60126.S | Besgo DN125 / d140 mm / 5" Sea water | 4 450 € |

HOW DOES IT WORK?

FILTRATION

Solenoid valve closed

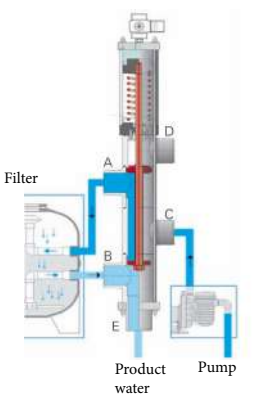

BACKWASH

Solenoid valve open

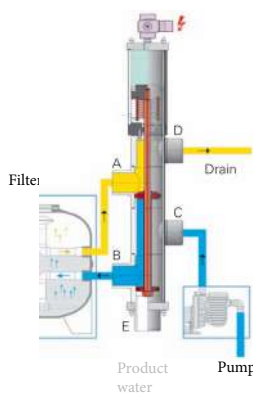

RINSING

Solenoid of 5 way valve closed / 3-way valve open

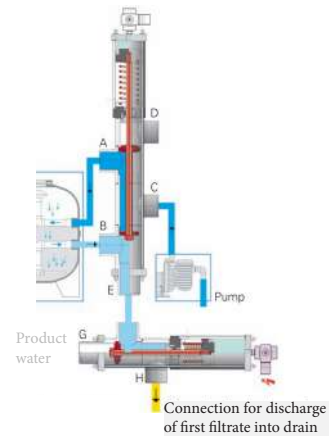

BACKWASH VALVES

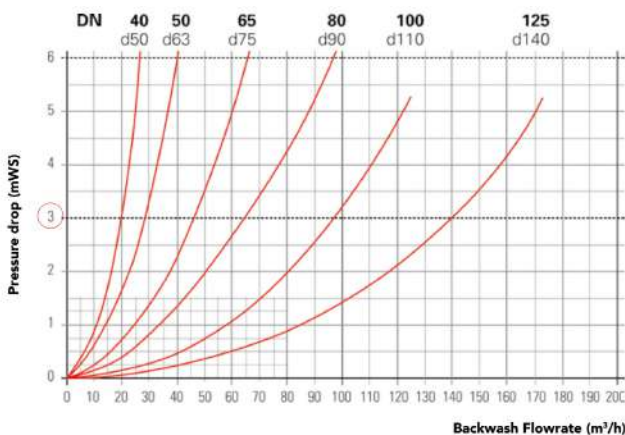

3-WAY VALVES

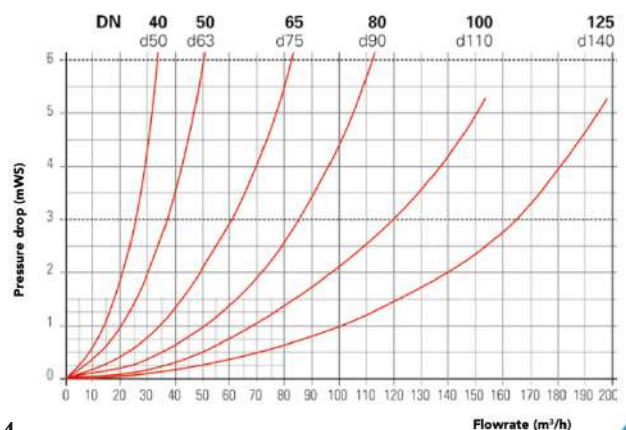

FLOWMETERS & AIR DIFFUSERS

FLOWMETERS



The Flow Meter FlowVis® from H2Flow can be installed in every direction and includes a non return Valve (DN 40 to DN 65). The average accuracy is 97.9%. The product is NSF 50 certified and a product of high quality. Scale in LPM.

| Ref | ID | Flow | Price |
|-------|---|----------------|-------|
| 63602 | FlowVis® d 25/32 mm | 1.2 - 5.4 m³/h | 129 € |
| 63604 | FlowVis® d 50 mm | 2.4-21 m³/h | 199 € |
| 63605 | FlowVis® d63 mm | 2.4-24 m³/h | 199 € |
| 63606 | FlowVis® d75 mm | 7 - 45 m³/h | 199 € |
| 63608 | FlowVis® d90 mm | 16-54 m³/h | 565 € |
| 63610 | FlowVis® d110 mm | 27-102 m³/h | 580 € |
| 63615 | FlowVis® d160 mm | 68 - 227 m³/h | 730 € |
| 63617 | FlowVis® d200 mm | 113 - 420 m³/h | 920 € |
| 63697 | FlowVis® Display extension cable 8 m | | 225 € |
| 63698 | FlowVis® Flapper with indicator and magnet d50mm-d75mm | | 30 € |
| 63699 | FlowVis® Digital Display for all installations: Digital Display in casing | | 870 € |

AIR DIFFUSERS



Dryden Aqua Air Diffusers are the best semi flexible fine bubble aeration system available in the market. They are 5 times more efficient than coarse bubble air diffusers in mixing action and aeration capacity, with an average bubble size of 1 mm. They usually connect to a circular ring main pipe with quick connections. The ring main pipe connects to a low pressure (around 1 bar) roots type or rotary vane air blower.

- Tubular diffuser up to 3m in length
- Air flow from 1 to 10 m3/h
- Oxygen transfer up to 5kg/kwh
- Less than 0.2 Bar (3psi) pressure differential
- Outer polyester jacket
- Internal glass bead ballast (self weighted)
- Plastic & stainless steel construction
- Simple installation
- Very easy maintenance

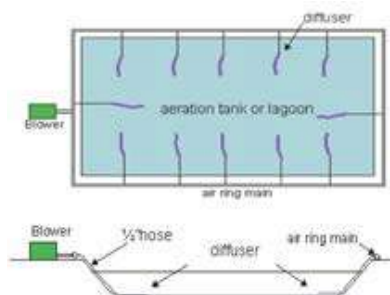

| Ref | ID | Diffuser Weight kg | Air Flow m³/h (+/- 20%) | Oxygen Transfer kg of O ₂ /day per diffuser at different depths at 20 °C and 50 % O ₂ saturation | | | Price |
|-------|-----------------|--------------------|-------------------------|--|-----------------------|----------------------|-------|
| | | | | 2 m | 3 m | 4 m | |
| 64301 | 0.33 m Diffuser | 0.5 | 1 | 2 kg O ₂ | 2.5 kg O ₂ | 3 kg O ₂ | 130 € |
| 64303 | 1.00 m Diffuser | 1.5 | 3 | 6 kg O ₂ | 7.5 kg O ₂ | 9 kg O ₂ | 160 € |
| 64306 | 2.00 m Diffuser | 3.0 | 6 | 14 kg O ₂ | 15 kg O ₂ | 18 kg O ₂ | 210 € |
| 64309 | 3.00 m Diffuser | 4.5 | 9 | 20 kg O ₂ | 22 kg O ₂ | 27 kg O ₂ | 250 € |

In water depths of >3 - 5m there may be a tendency for the diffusers to lift. Stainless steel ballast blocks are available that fit onto the hose end of the diffusers. These have a single air connection on the top and either one or four diffuser outlets, one on each side.

| | | |
|-------|---|-------|
| 64402 | Dryden Aqua Weight for Air Diffuser 75mm x 75mm; 2 Connections 1/2" | 180 € |
| 64405 | Diffuser ring adapter | 170 € |



Weight for air diffuser



USEFUL INFORMATION

NOZZLES PER PLATE

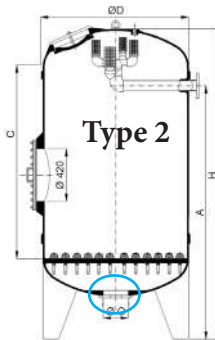
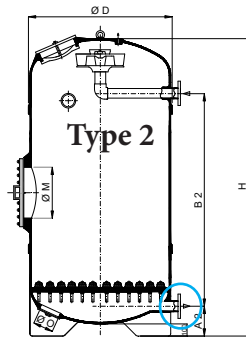
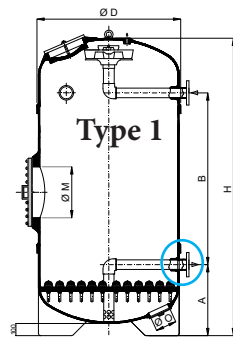

| Ø D | 415 | 460 | 520 | 640 | 720 | 840 | 960 | 1010 | 1160 | 1260 | 1440 | 1640 | 1840 | 2040 | 2210 | 2340 | 2550 | 2800 | 3000 |
|--------|-----|-----|-----|-----|-----|-----|-----|------|------|------|------|------|------|------|------|------|------|------|------|
| Type 1 | 12 | 12 | 15 | 20 | 24 | 35 | 43 | 48 | 64 | 84 | 96 | 132 | 172 | 212 | 235 | 284 | 336 | 419 | 484 |
| Type 2 | 12 | 12 | 16 | 21 | 25 | 36 | 44 | 53 | 69 | 89 | 101 | 137 | 177 | 217 | 240 | 289 | 341 | 428 | 489 |

CALPLAS INTERNAL DIAMETER/ SURFACE ACCORDING TO PRESSURE

Internal diameter estimation: This might change (Can be confirmed in manufacturing)

| Diameter | 2.5 kg/cm ² | | 4 kg/cm ² | | 5 kg/cm ² | | 6 kg/cm ² | | 7 kg/cm ² | |
|----------|------------------------|---------------------------|----------------------|---------------------------|----------------------|---------------------------|----------------------|---------------------------|----------------------|---------------------------|
| | Ø Int. (mm) | Surface (m ²) | Ø Int. (mm) | Surface (m ²) | Ø Int. (mm) | Surface (m ²) | Ø Int. (mm) | Surface (m ²) | Ø Int. (mm) | Surface (m ²) |
| 415 | 404 | 0,13 | * | * | 402 | 0,13 | * | * | 398 | 0,12 |
| 460 | 449 | 0,16 | * | * | 445 | 0,16 | * | * | 441 | 0,15 |
| 520 | 508 | 0,20 | * | * | 504 | 0,20 | * | * | 500 | 0,20 |
| 640 | 627 | 0,31 | * | * | 622 | 0,30 | * | * | 616 | 0,30 |
| 720 | 708 | 0,39 | * | * | 702 | 0,39 | * | * | 695 | 0,38 |
| 840 | 816 | 0,52 | * | * | 810 | 0,52 | * | * | 804 | 0,51 |
| 960 | 946 | 0,70 | * | * | 938 | 0,69 | * | * | 932 | 0,68 |
| 1010 | 994 | 0,78 | 990 | 0,77 | 986 | 0,76 | 984 | 0,76 | * | * |
| 1160 | 1135 | 1,01 | 1130 | 1,00 | 1126 | 1,00 | 1122 | 0,99 | * | * |
| 1260 | 1241 | 1,21 | 1238 | 1,20 | 1234 | 1,20 | 1230 | 1,19 | * | * |
| 1440 | 1405 | 1,55 | 1396 | 1,53 | 1390 | 1,52 | 1385 | 1,51 | * | * |
| 1640 | 1610 | 2,04 | 1600 | 2,01 | 1596 | 2,00 | 1590 | 1,99 | * | * |
| 1840 | 1790 | 2,52 | 1783 | 2,50 | 1777 | 2,48 | 1770 | 2,46 | * | * |
| 2040 | 2010 | 3,17 | 2000 | 3,14 | 1988 | 3,10 | 1978 | 3,07 | * | * |
| 2210 | 2190 | 3,77 | 2177 | 3,72 | 2165 | 3,68 | 2155 | 3,65 | * | * |
| 2340 | 2275 | 4,06 | 2262 | 4,02 | 2250 | 3,98 | 2240 | 3,94 | * | * |
| 2550 | 2500 | 4,91 | 2485 | 4,85 | 2475 | 4,81 | 2465 | 4,77 | * | * |
| 2800 | 2758 | 5,97 | 2734 | 5,87 | 2728 | 5,84 | 2720 | 5,81 | * | * |
| 3000 | 2964 | 6,90 | 2937 | 6,77 | 2928 | 6,73 | 2918 | 6,69 | * | * |

CALPLAS LEG INFORMATION / FIXING HOLES DATA

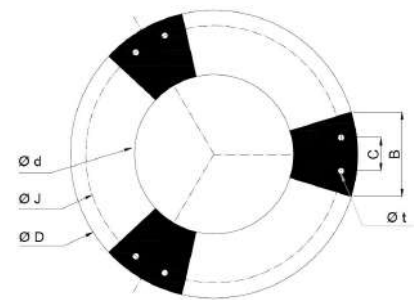

| Ø | D | d | J | B | C | t |
|------|---------------|------|------|-----|-----|----|
| 415 | 400 | 310 | 355 | 90 | 0 | 12 |
| 460 | 440 | 340 | 390 | 95 | 0 | 12 |
| 520 | 503 | 493 | 450 | 105 | 0 | 12 |
| 640 | 612 | 482 | 550 | 120 | 0 | 12 |
| 720 | 670 | 510 | 600 | 130 | 0 | 14 |
| 840 | 795 | 615 | 705 | 140 | 0 | 14 |
| 960 | 925 | 725 | 825 | 160 | 0 | 14 |
| 1010 | 970 | 470 | 830 | 250 | 0 | 16 |
| 1160 | 1120 | 620 | 1000 | 270 | 130 | 16 |
| 1260 | 1215 | 670 | 1125 | 290 | 150 | 16 |
| 1440 | 1380 | 780 | 1250 | 325 | 170 | 16 |
| 1640 | 1560 | 810 | 1400 | 370 | 190 | 16 |
| 1840 | 1760 | 1060 | 1610 | 370 | 200 | 20 |
| 2040 | 1980 | 1230 | 1800 | 410 | 200 | 20 |
| 2210 | 2160 | 1450 | 1960 | 430 | 220 | 20 |
| 2340 | 2240 | 1440 | 2000 | 450 | 220 | 20 |
| 2550 | 2435 | 1550 | 2200 | 550 | 250 | 20 |
| 2800 | 2700 | 1700 | 2400 | 570 | 250 | 20 |
| 3000 | CHECK WITH US | | | | | |

FLANGES INFORMATION DIN PN10

| Connection | Inch | i | D _c | K | N° Holes | ØHole |
|------------|--------|----------|----------------|-----|----------|-------|
| DN15 | 1/2" | 20 | 95 | 65 | 4 | 14 |
| DN20 | 3/4" | 25 | 105 | 75 | 4 | 14 |
| DN25 | 1" | 32 | 115 | 85 | 4 | 14 |
| DN32 | 1 1/4" | 40 | 140 | 110 | 4 | 18 |
| DN40 | 1 1/2" | 50 | 150 | 110 | 4 | 18 |
| DN50 | 2" | 63 | 165 | 125 | 4 | 18 |
| DN65 | 2 1/2" | 75 | 185 | 145 | 4 | 18 |
| DN80 | 3" | 90 | 200 | 160 | 8 | 18 |
| DN100 | 4" | 110 | 220 | 180 | 8 | 18 |
| DN110 | -- | 125 | 230 | 190 | 8 | 18 |
| DN125 | 5" | *125/140 | 250 | 210 | 8 | 18 |
| DN150 | 6" | 160 | 285 | 240 | 8 | 22 |
| DN175 | -- | 200 | 315 | 270 | 8 | 22 |
| DN200 | 8" | 225 | 340 | 295 | 8 | 22 |
| DN250 | 10" | *250/280 | 395 | 350 | 12 | 22 |
| DN300 | 12" | 315 | 445 | 400 | 12 | 22 |
| DN350 | 14" | 355 | 505 | 460 | 16 | 22 |
| DN400 | 16" | 400 | 565 | 515 | 16 | 26 |
| DN500 | 20" | 560 | 670 | 620 | 20 | 26 |

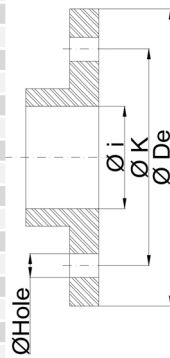

* With this sizes, please always inform about pipe dimension.
ANSI and JIS also available

USEFUL INFORMATION

CALPLAS FILTERS INFORMATION

| Diameter | Standard Connection (Filters) | Besgo automatic valve compability | Manhole size (mm) | Sightglass size | Filtering surface 2.5 Kg/cm ² (m ²) | Volume to cover laterals (liters) | Volume to cover nozzle plate (liters) | Volume for Δ 100 mm (liters) |
|----------|-------------------------------|-----------------------------------|-------------------|-----------------|--|-----------------------------------|---------------------------------------|------------------------------|
| 415 | 2" | Besgo AG | 305 | 2 1/2" | 0,13 | 8 | 7 (50 mm) | 13 |
| 460 | 2" | Besgo AG | 305 | 2 1/2" | 0,16 | 11 | 8 (50 mm) | 16 |
| 520 | 2" | Besgo AG | 305 | 2 1/2" | 0,20 | 14 | 11 (50 mm) | 21 |
| 640 | 2" | Besgo AG | 355 | 3" | 0,31 | 27 | 16 (50 mm) | 31 |
| 720 | 2" | Besgo AG | 355 | 3" | 0,39 | 43 | 20 (50 mm) | 40 |
| 840 | 2" | Besgo AG | 355 | 3" | 0,52 | 73 | 27 (50 mm) | 53 |
| 960 | 2 1/2" | Besgo AG | 420 | 4" | 0,70 | 105 | 36 (50 mm) | 71 |
| 1010 | DN80 | Besgo AG | 420 / 500 | 4" | 0,78 | 105 | 78 (100 mm) | 78 |
| 1160 | DN80/DN100 | Besgo AG | 420 / 500 | 4" | 1,01 | 127 | 102 (100 mm) | 102 |
| 1260 | DN100 | Besgo AG | 420 / 500 | 4" | 1,21 | 163 | 121 (100 mm) | 121 |
| 1440 | DN100 | Besgo AG | 420 / 500 | 4" | 1,55 | 249 | 155 (100 mm) | 155 |
| 1640 | DN125 | Besgo AG | 420 / 500 | 5" | 2,04 | 371 | 204 (100 mm) | 204 |
| 1840 | DN125 | Besgo AG | 420 / 500 | 5" | 2,52 | 515 | 252 (100 mm) | 252 |
| 2040 | DN150 | Besgo AG | 420 / 500 | 6" | 3,17 | 699 | 318 (100 mm) | 318 |
| 2210 | DN200 | | 420 / 500 | 6" | 3,77 | 971 | 377 (100 mm) | 377 |
| 2340 | DN200 | | 420 / 500 | 6" | 4,06 | 1.039 | 407 (100 mm) | 407 |
| 2550 | DN200 | | 420 / 500 | 6" | 4,91 | 1.325 | 491 (100 mm) | 491 |
| 2800 | DN250 | | 420 / 500 | 6" | 5,97 | 2.070 | 598 (100 mm) | 598 |
| 3000 | DN250 | | 420 / 500 | 6" | 6,90 | 2.212 | 690 (100 mm) | 690 |

FLOW (m³/h) AT DIFFERENT VELOCITIES (Calculated 2.5 bar design pressure internal diameter)

| Diameter | Flow at 5 m/h | Flow at 10 m/h | Flow at 15 m/h | Flow at 20 m/h | Flow at 25 m/h | Flow at 30 m/h | Flow at 35 m/h | Flow at 40 m/h | Flow at 45 m/h | Flow at 50 m/h | Flow at 55 m/h | Flow at 60 m/h |
|----------|---------------|----------------|----------------|----------------|----------------|----------------|----------------|----------------|----------------|----------------|----------------|----------------|
| 415 | 0,65 | 1,3 | 1,95 | 2,6 | 3,25 | 3,9 | 4,55 | 5,2 | 5,85 | 6,5 | 7,15 | 7,8 |
| 460 | 0,8 | 1,6 | 2,4 | 3,2 | 4 | 4,8 | 5,6 | 6,4 | 7,2 | 8 | 8,8 | 9,6 |
| 520 | 1 | 2 | 3 | 4 | 5 | 6 | 7 | 8 | 9 | 10 | 11 | 12 |
| 640 | 1,55 | 3,1 | 4,65 | 6,2 | 7,75 | 9,3 | 10,85 | 12,4 | 13,95 | 15,5 | 17,05 | 18,6 |
| 720 | 1,95 | 3,9 | 5,85 | 7,8 | 9,75 | 11,7 | 13,65 | 15,6 | 17,55 | 19,5 | 21,45 | 23,4 |
| 840 | 2,6 | 5,2 | 7,8 | 10,4 | 13 | 15,6 | 18,2 | 20,8 | 23,4 | 26 | 28,6 | 31,2 |
| 960 | 3,5 | 7 | 10,5 | 14 | 17,5 | 21 | 24,5 | 28 | 31,5 | 35 | 38,5 | 42 |
| 1010 | 3,9 | 7,8 | 11,7 | 15,6 | 19,5 | 23,4 | 27,3 | 31,2 | 35,1 | 39 | 42,9 | 46,8 |
| 1160 | 5,05 | 10,1 | 15,15 | 20,2 | 25,25 | 30,3 | 35,35 | 40,4 | 45,45 | 50,5 | 55,55 | 60,6 |
| 1260 | 6,05 | 12,1 | 18,15 | 24,2 | 30,25 | 36,3 | 42,35 | 48,4 | 54,45 | 60,5 | 66,55 | 72,6 |
| 1440 | 7,75 | 15,5 | 23,25 | 31 | 38,75 | 46,5 | 54,25 | 62 | 69,75 | 77,5 | 85,25 | 93 |
| 1640 | 10,2 | 20,4 | 30,6 | 40,8 | 51 | 61,2 | 71,4 | 81,6 | 91,8 | 102 | 112,2 | 122,4 |
| 1840 | 12,6 | 25,2 | 37,8 | 50,4 | 63 | 75,6 | 88,2 | 100,8 | 113,4 | 126 | 138,6 | 151,2 |
| 2040 | 15,85 | 31,7 | 47,55 | 63,4 | 79,25 | 95,1 | 110,95 | 126,8 | 142,65 | 158,5 | 174,35 | 190,2 |
| 2210 | 18,85 | 37,7 | 56,55 | 75,4 | 94,25 | 113,1 | 131,95 | 150,8 | 169,65 | 188,5 | 207,35 | 226,2 |
| 2340 | 20,3 | 40,6 | 60,9 | 81,2 | 101,5 | 121,8 | 142,1 | 162,4 | 182,7 | 203 | 223,3 | 243,6 |
| 2550 | 24,55 | 49,1 | 73,65 | 98,2 | 122,75 | 147,3 | 171,85 | 196,4 | 220,95 | 245,5 | 270,05 | 294,6 |
| 2800 | 29,85 | 59,7 | 89,55 | 119,4 | 149,25 | 179,1 | 208,95 | 238,8 | 268,65 | 298,5 | 328,35 | 358,2 |
| 3000 | 34,5 | 69 | 103,5 | 138 | 172,5 | 207 | 241,5 | 276 | 310,5 | 345 | 379,5 | 414 |

PACKAGING INFORMATION IN CALPLAS EQUIPMENT

PUMP STRAINERS & MEDIATRAPS

Calplas Pump strainers & mediatraps are sent in carton box which is included in the price.

FA HFX AFM & VESSELS WITH THREADED CONNECTIONS

Calplas vessels with threaded connections are sent in carton box which is included in the price.

VESSELS WITH FLANGED CONNECTIONS

Calplas vessels with flanged connections require a wooden box crate if it is sharing transport with other loads. Please see prices below.



FB

| Model | Net Price |
|------------------|-----------|
| FB-40 to FB-80 | 135 € |
| FB-100 to FB-175 | 215 € |
| FB-200 | 230 € |
| FB-250 | 260 € |
| FB-300 | 320 € |
| FB-350 | 355 € |

COLUMNS WITH FLANGES

| Model | Net Price |
|-------------------|-----------|
| Ø415 to Ø640 mm | 90 € |
| Ø720 to Ø960 mm | 140 € |
| Ø1010 to Ø1260 mm | 170 € |
| Ø1440 to Ø1640 mm | 270 € |
| Ø1840 to Ø2210 mm | 335 € |
| Ø2340 mm | 390 € |
| Ø2550 mm | 480 € |
| Ø2800 mm | 530 € |
| Ø3000 mm | 620 € |

FULL TRUCK (DIRECT SHIPMENT TO INSTALLATION)

For some installations a direct shipment can be done, with a full truck load, under this circumstances wooden box crates can be avoided under customers responsibility not to damage the filters on the unloading process.



NOTES



Lined area for notes, consisting of numerous horizontal lines.





calplas@calplas.com
www.calplas.com

Polígono Txirrita-Maleo
Pabellón nº 9
20100 Rentería (Guipuzcoa)-España
Tel.: + 34 943 49 05 01